



2027

**Sponsorship Preview**  
Convention Center Branding Opportunities



## Commodity Classic 2027 Sponsorship Opportunities

- Agri-Industry Tours
- Beverage Greetings
- Email Ad
- Chair Massages
- Closing Party
- Convention Badge Lanyards
- Device Charging Locations
- Education: Commodity Classic Main Stage presented by Successful Farming
- Education: Learning Centers & Early Risers
- Education: Mini What's New Sessions
- Education: What's New Sessions
- First-Time Attendee Reception
- General Session
- General Support
- Hotel Room Key Cards
- Hotel Shuttles
- Land Blessing Ceremony
- LEGO® Creation
- Lounges/Branded Seating
- Luggage & Coat Check with Luggage Tags
- Media Room & Media Reception
- Mobile App
- Outdoor Display
- Photo Opps
- Puppy Patch
- Program Booklet – Back Cover Ad
- Program Booklet – Interior Ad
- Registration Brochure
- Registration Tote Bags
- Reusable Water Bottles
- Signage & Branding: Convention Center
- Signage & Branding: Hotels
- Spin It to Win It
- Trade Show Courtesy Rides
- Trade Show Grand Opening & Daily Sponsor (Day 1: Wednesday)
- Trade Show & Lunch Daily Sponsor (Day 2: Thursday)
- Trade Show & Lunch Daily Sponsor (Day 3: Friday)
- Video Wall Advertising
- Welcome Reception
- WiFi
- Your fun idea that we haven't thought of!

**2026 sponsors have first right of refusal for some items listed above**



## Sponsorship Opportunities New Orleans Convention Center Level 1

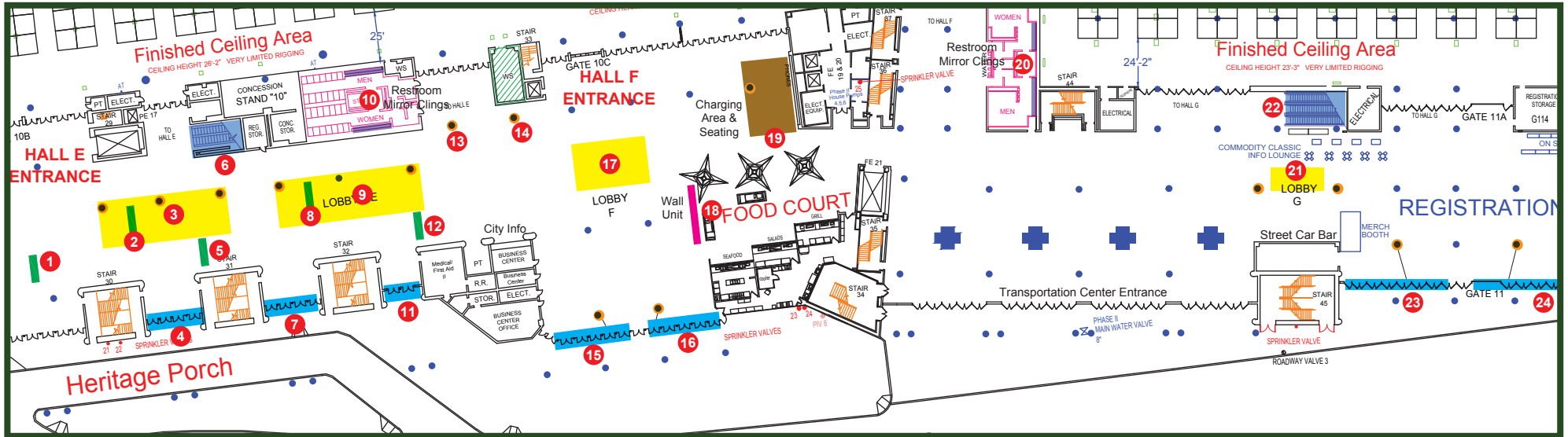

- - Window Clings
- - Floor Cling
- - Escalator
- - I-Cove Charging Area
- - Column Wrap
- - Banner
- - Wall Cling
- - Other

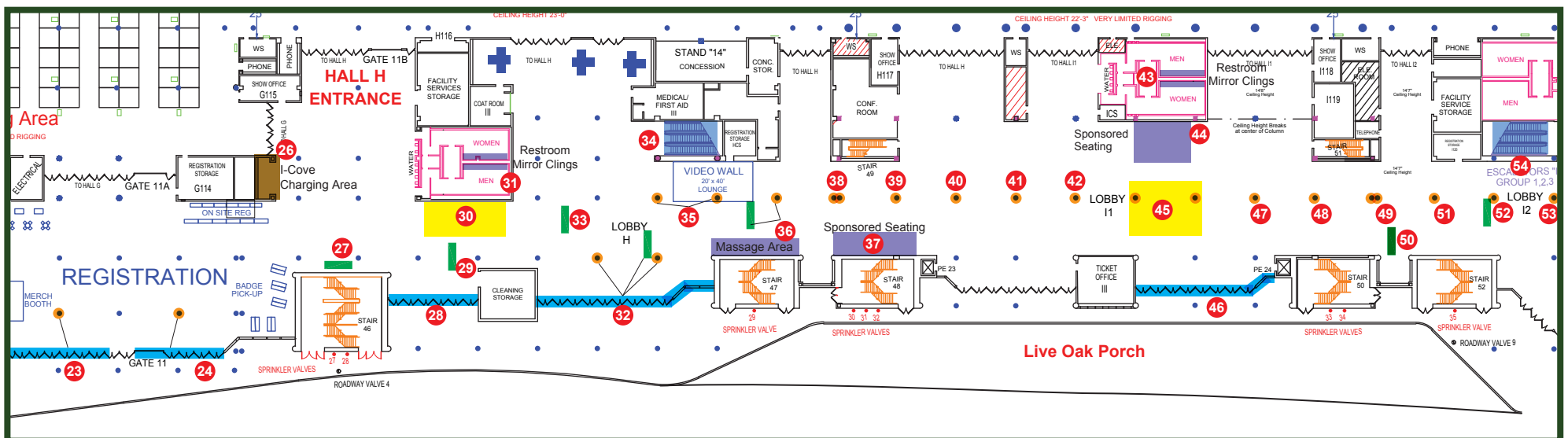



## Sponsorship Opportunities New Orleans Convention Center Level 2

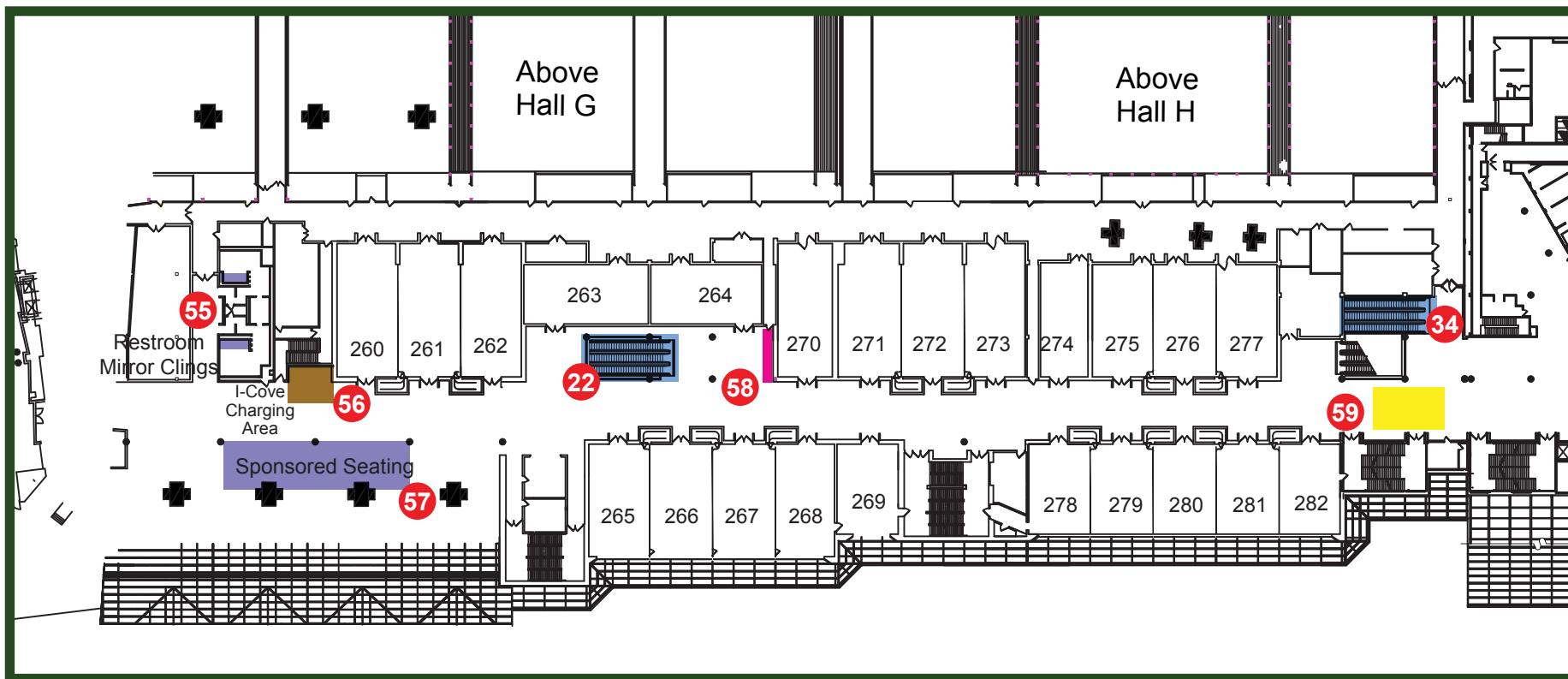

- Floor Cling
- Wall Cling
- Escalator
- I-Cove Charging Area
- Other



## Artwork Pricing Deadlines & Guidelines

Artwork Deadline: Coming Soon

Paramount will send off all graphics to Hotels/Convention Center for final approval before printing.

---

### **Sending Files:**

Please send all graphics as print ready PDF(200dpi+) with NO BLEEDS.  
Make sure all fonts are outlined and all images are linked/embedded.

If you send a file at something other than 100% please make a note of this when sending your files.

All files must be uploaded to Paramount Convention Services FTP.  
You will be provided with login and password information when you are ready to upload.

---

### **Special Notes:**

Window Clings have such a variance in size and very large quantities for some of the window banks. We are requesting that you send a mock-up along with the print ready artwork. This will ensure that your graphics are laid out correctly on site.

Column Wraps are built using Paramount's metal system. All panels will tuck into the metal structure .25" on all edges. If you have graphics that span the vertical or horizontal metal bars, please compensate for the gap of the bar (2").

If you have any other questions or concerns regarding graphics, contact Chris Shatto at Paramount Convention Services.

314.621.6677 or [Chris@paramountcs.com](mailto:Chris@paramountcs.com)



OPPORTUNITY #1

# Hanging Banner Hall E Lobby

Double Sided

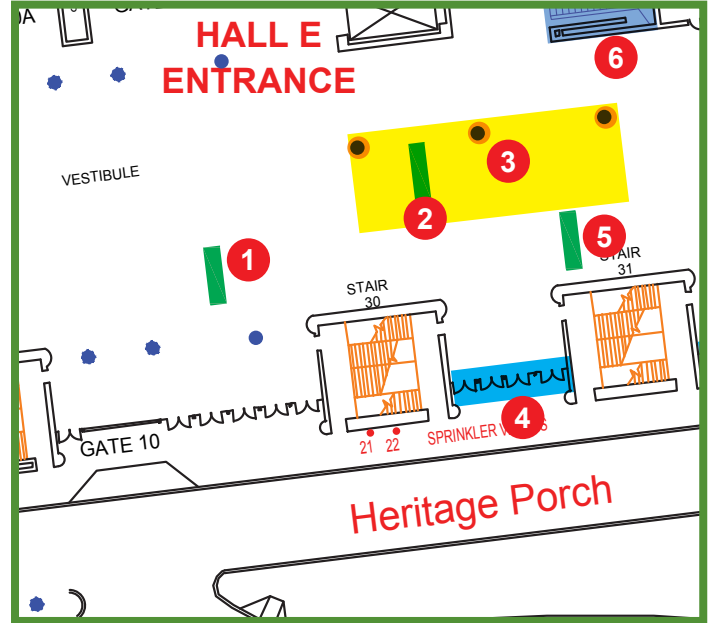

Sponsorship Location Fee  
Coming Soon

Printing & Installation Fee  
Coming Soon

## Hanging Banner

120" x 96"



120"

96"



# Hanging Banner Hall E Lobby

Double Sided

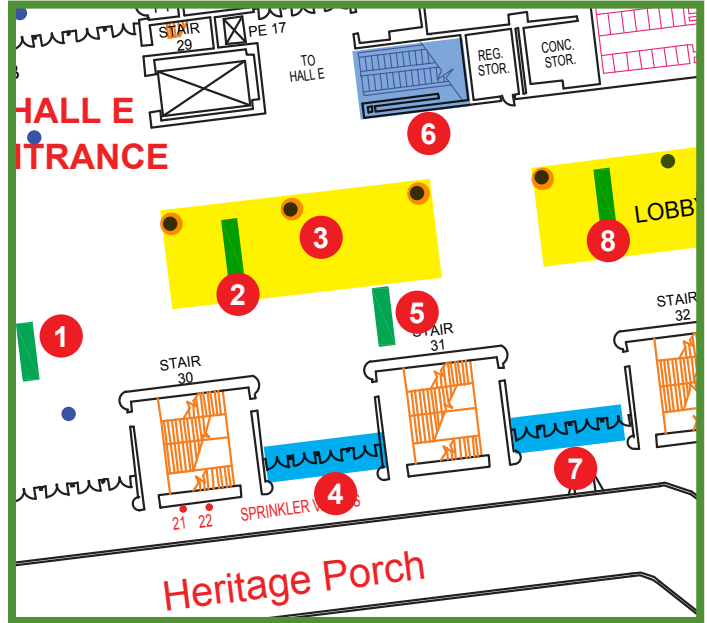

**Sponsorship Location Fee**  
Coming Soon

**Printing & Installation Fee**  
Coming Soon

## Hanging Banner

120" x 96"





# Floor Cling & Column Wraps Hall E Lobby

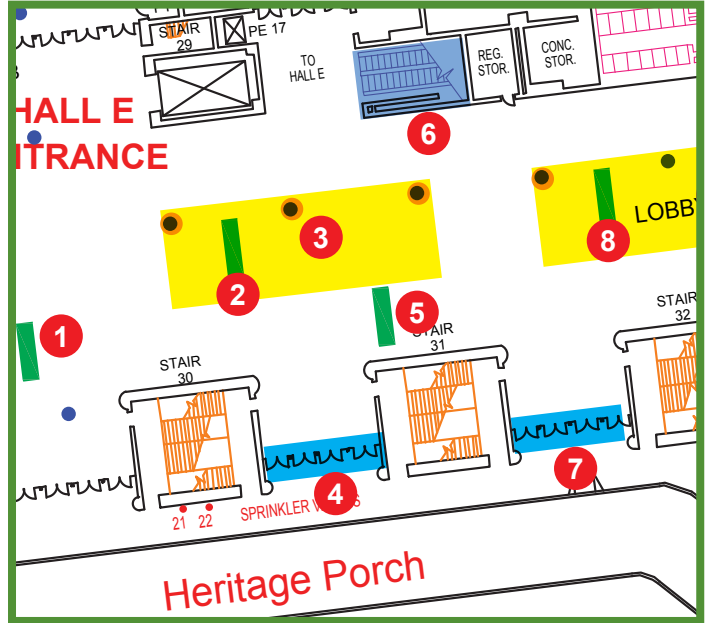

**Sponsorship Location Fee**  
Coming Soon

**Printing & Installation Fee**  
Coming Soon

### Floor Clings

Clings bigger than 50" x 50" will be tiled.

### Additional Information

Floor cling printing & installation pricing is dependent on quantity and size of clings within the given area.

### Column Wraps (x3) 16' tall

Wraps will be made with agam metal (see mockup at right)

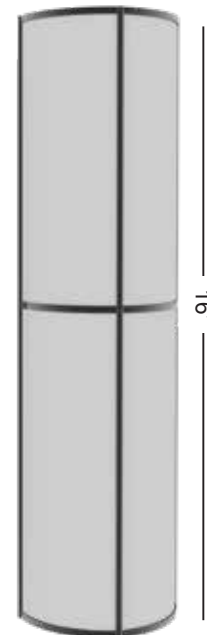



### Window Clings Hall E Lobby

Inside facing

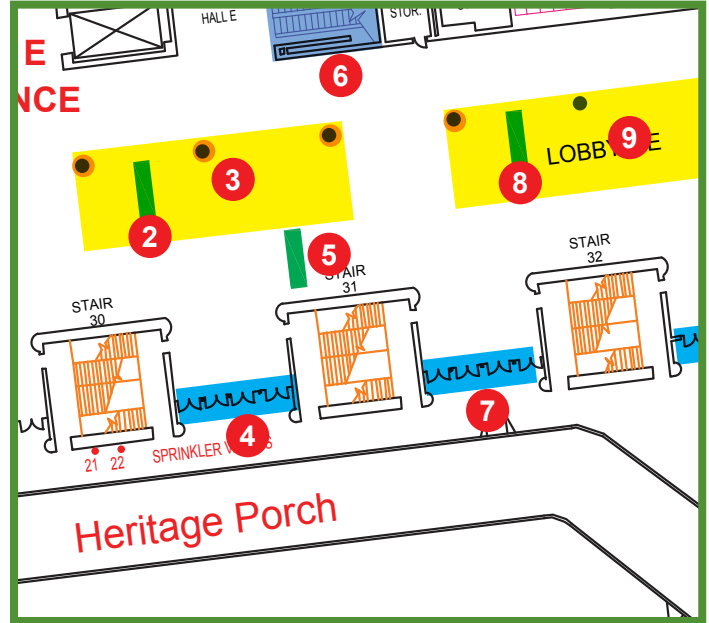

**Sponsorship Location Fee**  
Coming Soon

**Printing & Installation Fee**  
Coming Soon

### Window Clings

- A: 88" x 72.875" (x4)
- B: 88" x 30.375" (x4)
- C: 88" x 68.375" (x4)
- D: 34.875" x 34.5" (x8)

A <sub>1</sub>	A <sub>2</sub>	A <sub>3</sub>	A <sub>4</sub>				
B <sub>1</sub>	B <sub>2</sub>	B <sub>3</sub>	B <sub>4</sub>				
C <sub>1</sub>	C <sub>2</sub>	C <sub>3</sub>	C <sub>4</sub>				
No Graphics Above Door Handles							
D <sub>1</sub>	D <sub>2</sub>	D <sub>3</sub>	D <sub>4</sub>	D <sub>5</sub>	D <sub>6</sub>	D <sub>7</sub>	D <sub>8</sub>



# Hanging Banner Hall E Lobby

Double Sided

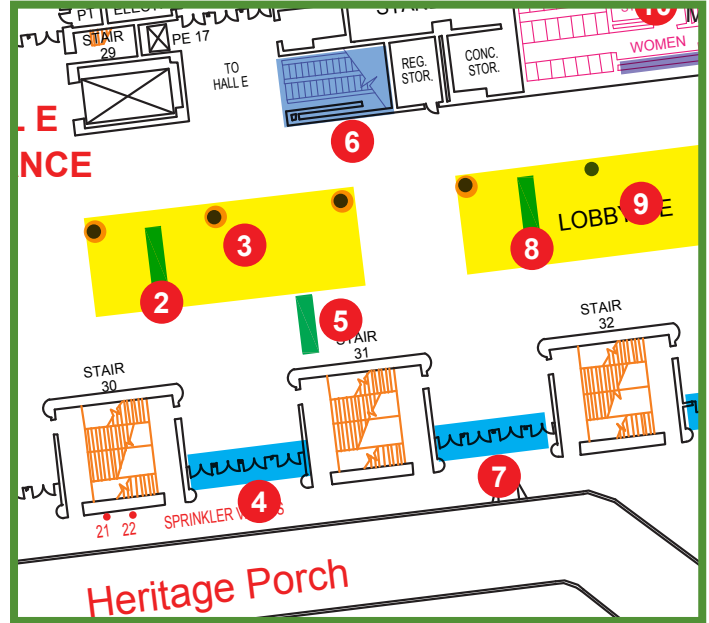

**Sponsorship Location Fee**  
Coming Soon

**Printing & Installation Fee**  
Coming Soon

## Hanging Banner

120" x 96"





### Escalator Clings Hall E Lobby

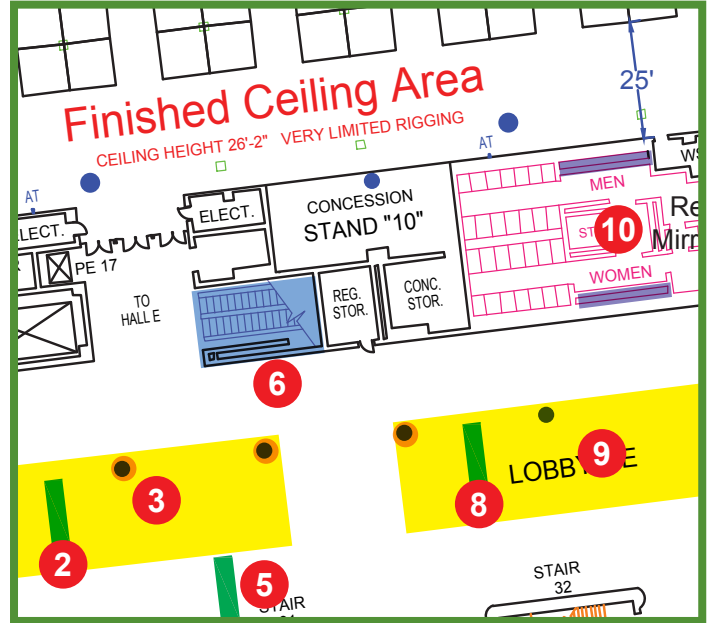

**Sponsorship Location Fee**  
Coming Soon

**Printing & Installation Fee**  
Coming Soon

### Escalator Clings

Metal Sides: 58' x 23.5" (x6)  
Flat Divider: 11.5" x 71" (x2)

### Additional Information

Escalator goes up to Education Sessions, General Session, Association Meetings.

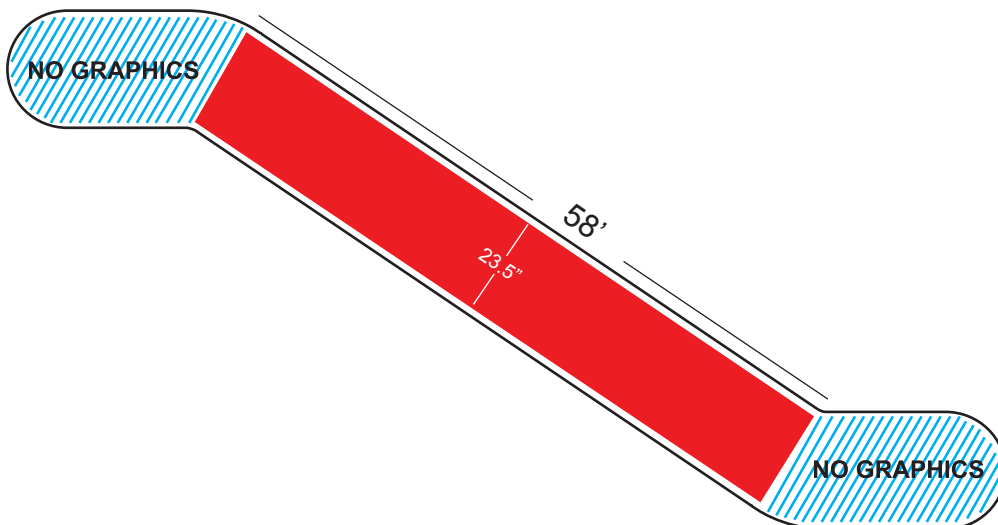



### Window Clings Hall E Lobby

Inside facing

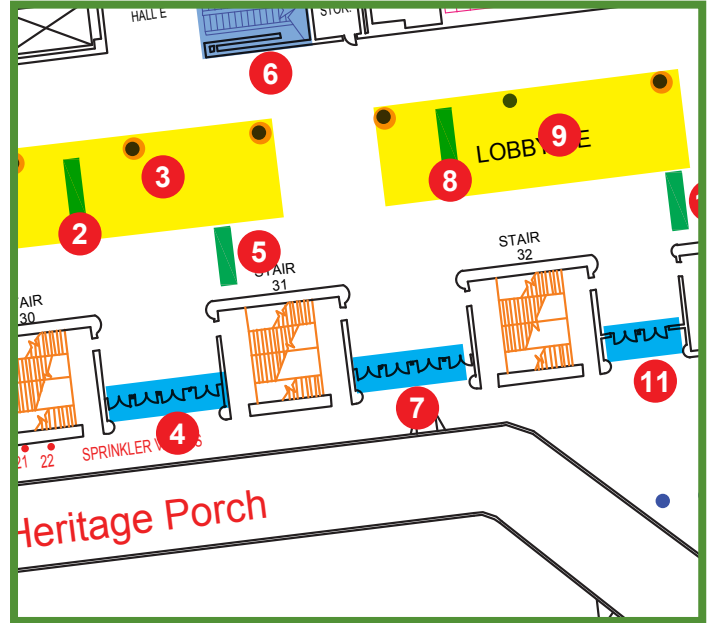

**Sponsorship Location Fee**

Coming Soon

**Printing & Installation Fee**

Coming Soon

### Window Clings

- A: 88" x 72.875" (x4)
- B: 88" x 30.375" (x4)
- C: 88" x 68.375" (x4)
- D: 34.875" x 34.5" (x8)

A <sub>1</sub>	A <sub>2</sub>	A <sub>3</sub>	A <sub>4</sub>				
B <sub>1</sub>	B <sub>2</sub>	B <sub>3</sub>	B <sub>4</sub>				
C <sub>1</sub>	C <sub>2</sub>	C <sub>3</sub>	C <sub>4</sub>				
No Graphics Above Door Handles							
D <sub>1</sub>	D <sub>2</sub>	D <sub>3</sub>	D <sub>4</sub>	D <sub>5</sub>	D <sub>6</sub>	D <sub>7</sub>	D <sub>8</sub>



# Hanging Banner Hall E Lobby

Double Sided

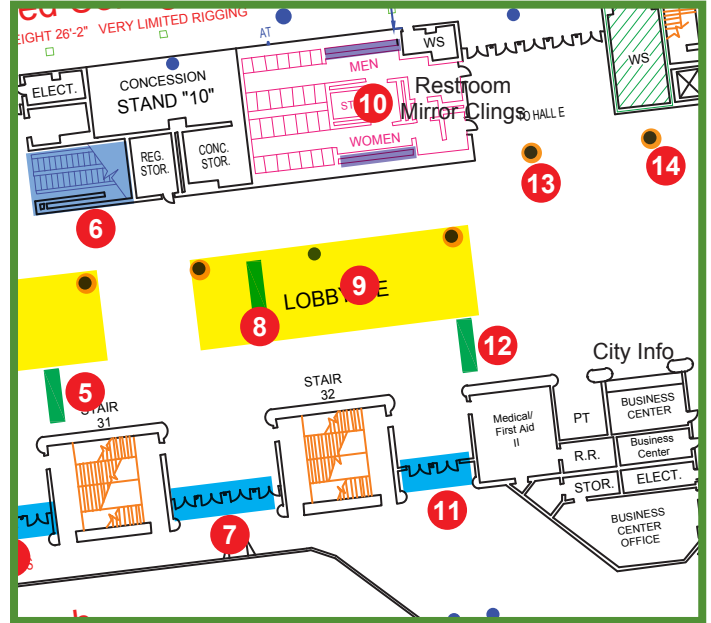

**Sponsorship Location Fee**  
Coming Soon

**Printing & Installation Fee**  
Coming Soon

## Hanging Banner

120" x 96"



120"

96"



### Floor Cling & Column Wraps Hall E Lobby

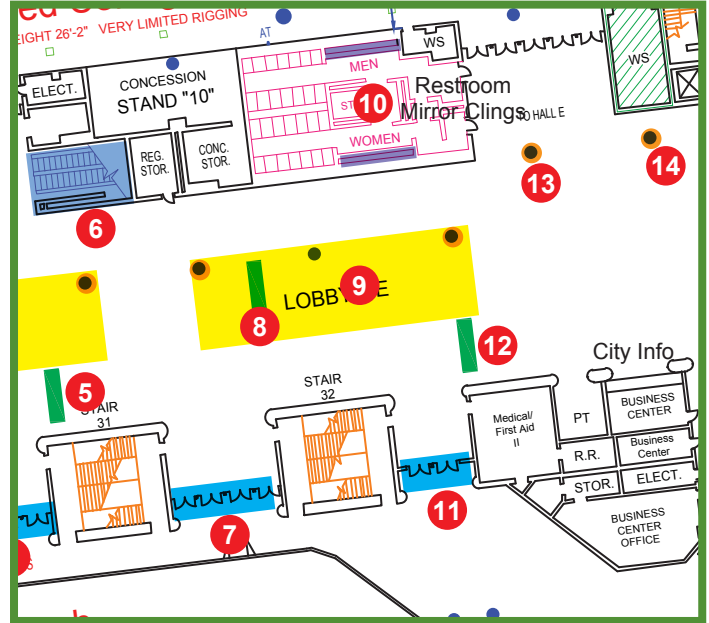

**Sponsorship Location Fee**  
Coming Soon

**Printing & Installation Fee**  
Coming Soon

#### Floor Cling

Clings bigger than 50" x 50" will be tiled.

#### Location Information

Floor cling printing & installation pricing is dependent on quantity and size of clings within the given area.

#### Column Wraps (x2) 16' tall

Wraps will be made with agam metal (see mockup at right)

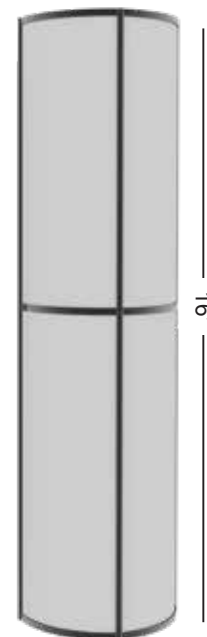



### Restroom Mirror Clings Hall E Lobby



**Sponsorship Location Fee**  
Coming Soon

**Printing & Installation Fee**  
Coming Soon

**Mirror Clings** 16" x 16"

Clings placed on lower right corner of mirrors.  
(3-4 mirrors per restroom)

**Additional Information**

This opportunity includes the Men's and Women's restrooms in this location.



### Window Clings Hall E Lobby

Inside facing

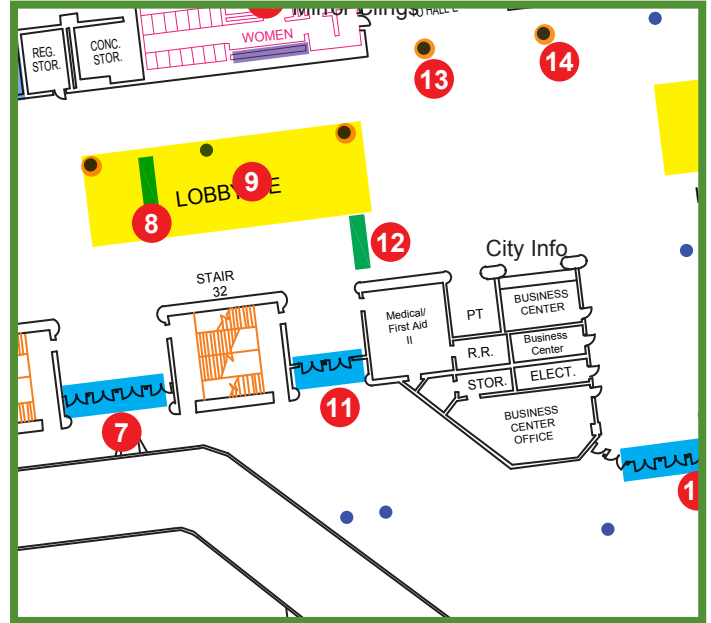

**Sponsorship Location Fee**  
Coming Soon

**Printing & Installation Fee**  
Coming Soon

### Window Clings

- A: 88" x 72.875" (x2)
- B: 88" x 30.375" (x2)
- C: 88" x 68.375" (x2)
- D: 34.875" x 34.5" (x2)
- E: 34" x 30.375" (x2)
- F: 34" x 68.375" (x2)
- G: 34" x 90" (x2)
- H: 34.875" x 34.5" (x4)

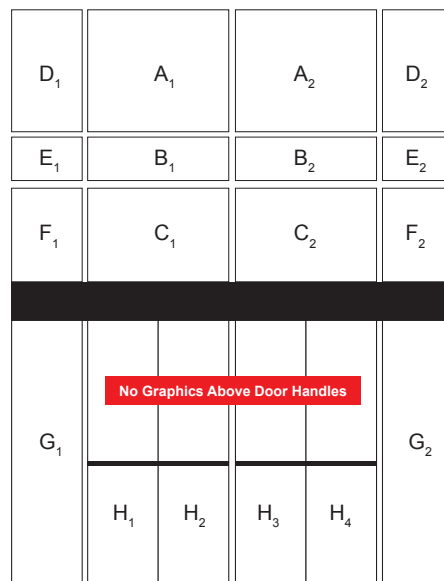



# Hanging Banner Hall E Lobby

Double Sided

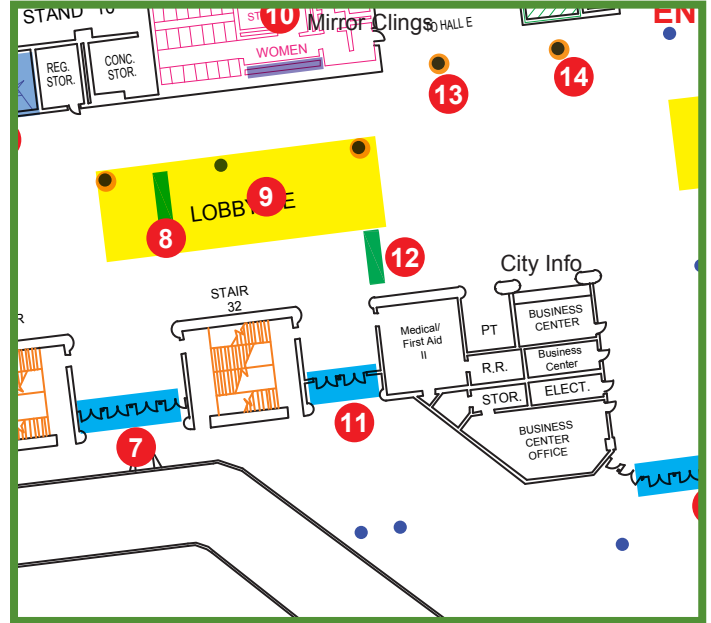

**Sponsorship Location Fee**  
Coming Soon

**Printing & Installation Fee**  
Coming Soon

## Hanging Banner

120" x 96"



120"

96"



## Column Wrap Hall E Lobby

OPPORTUNITY #13



**Sponsorship Location Fee**  
Coming Soon

**Printing & Installation Fee**  
Coming Soon

### **Column Wrap** (x1) 12' tall

Wraps will be made with agam metal  
(see mockup at right)

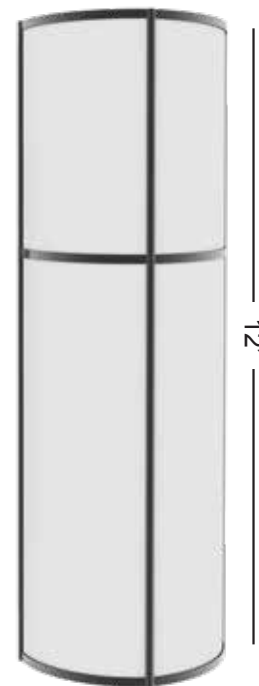



# Column Wrap Hall E Lobby

OPPORTUNITY #14

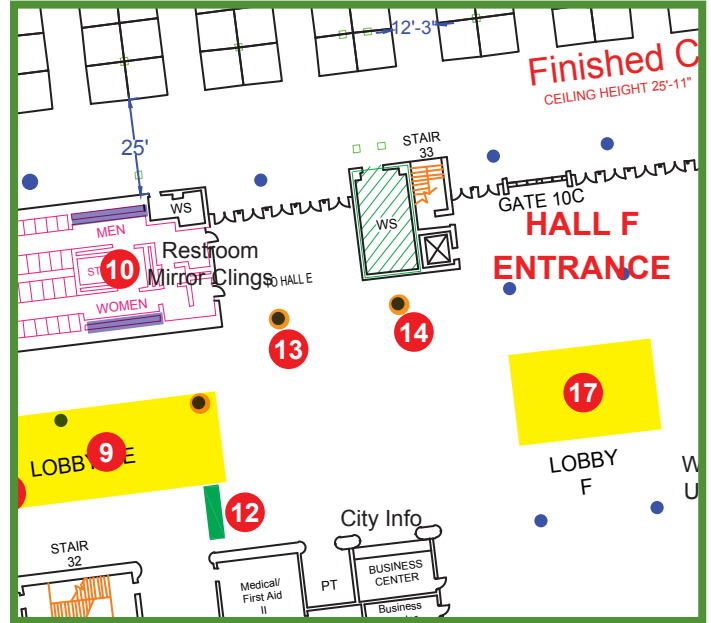

**Sponsorship Location Fee**  
Coming Soon

**Printing & Installation Fee**  
Coming Soon

**Column Wrap** (x1) 12' tall

Wraps will be made with agam metal  
(see mockup at right)

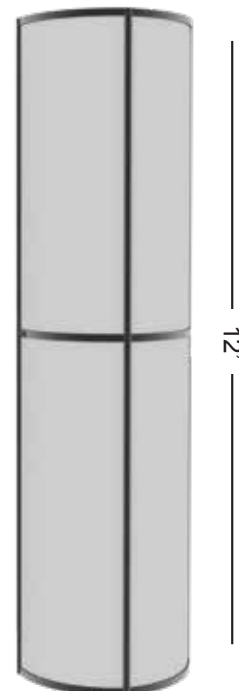



# Window Clings & Column Wrap

## Hall F Lobby

Inside facing

OPPORTUNITY #15

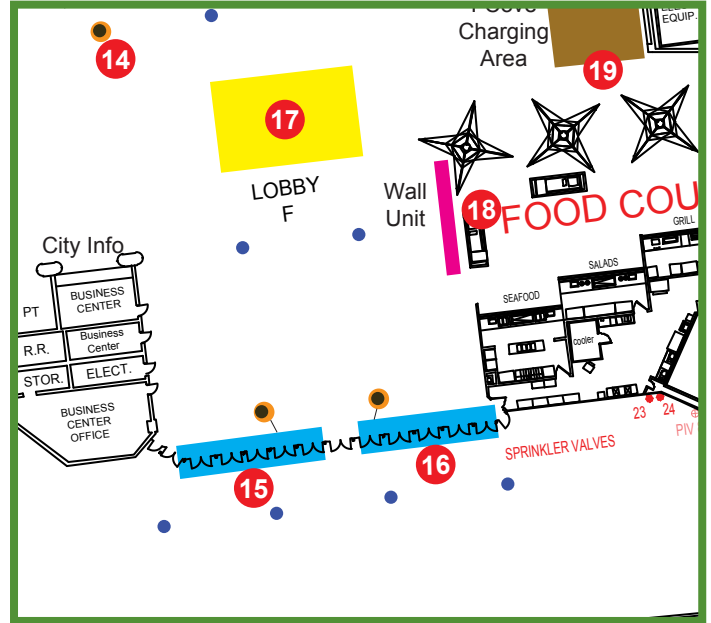

**Sponsorship Location Fee**  
Coming Soon

**Printing & Installation Fee**  
Coming Soon

### Window Clings

- A: 44.5" x 32.75" (x1)    E: 88" x 30.375" (x5)
- B: 44.5" x 30.375" (x1)    F: 88" x 68.375" (x5)
- C: 44.5" x 68.375" (x1)    G: 34.875" x 34.5" (x11)
- D: 88" x 32.75" (x5)

### Column Wrap (x1) 16' tall

Wraps will be made with agam metal (see mockup below)

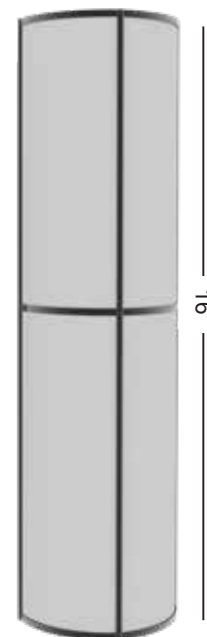

No Graphics	D <sub>8</sub>	D <sub>9</sub>	D <sub>10</sub>	D <sub>11</sub>	D <sub>12</sub>	A <sub>2</sub>							
	E <sub>8</sub>	E <sub>9</sub>	E <sub>10</sub>	E <sub>11</sub>	E <sub>12</sub>	B <sub>2</sub>							
	F <sub>8</sub>	F <sub>9</sub>	F <sub>10</sub>	F <sub>11</sub>	F <sub>12</sub>	C <sub>2</sub>							
No Graphics	No Graphics Above Door Handles												
No Graphics	G <sub>14</sub>	G <sub>15</sub>	G <sub>16</sub>	G <sub>17</sub>	G <sub>18</sub>	G <sub>19</sub>	G <sub>20</sub>	G <sub>21</sub>	G <sub>22</sub>	G <sub>23</sub>	G <sub>24</sub>	G <sub>25</sub>	G <sub>26</sub>



# Window Clings & Column Wrap

## Hall F Lobby

Inside facing

OPPORTUNITY #16

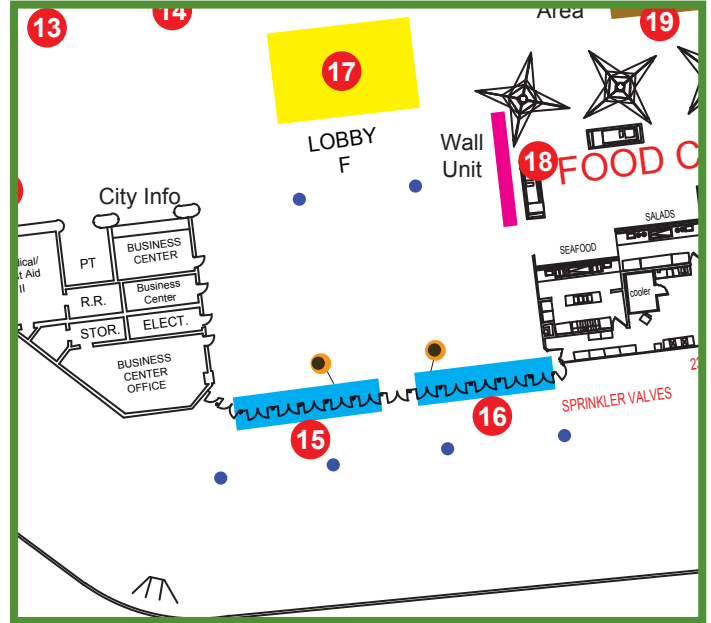

**Sponsorship Location Fee**  
Coming Soon

**Printing & Installation Fee**  
Coming Soon

### Window Clings

- A: 44.5" x 32.75" (x1)    E: 88" x 30.375" (x5)
- B: 44.5" x 30.375" (x1)    F: 88" x 68.375" (x5)
- C: 44.5" x 68.375" (x1)    G: 34.875" x 34.5" (x11)
- D: 88" x 32.75" (x5)

### Column Wrap (x1) 16' tall

Wraps will be made with agam metal (see mockup below)

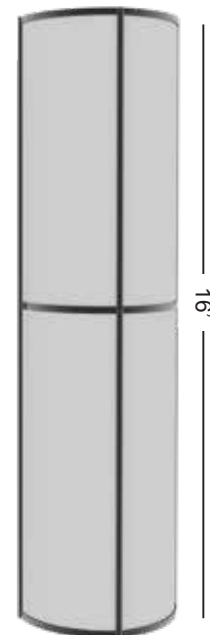
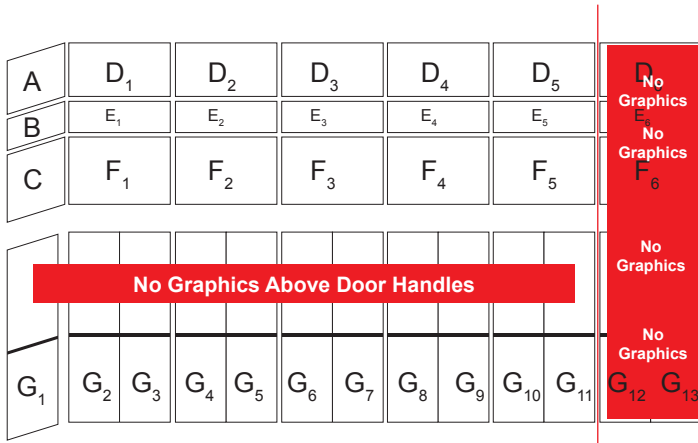



### Floor Cling Hall F Lobby

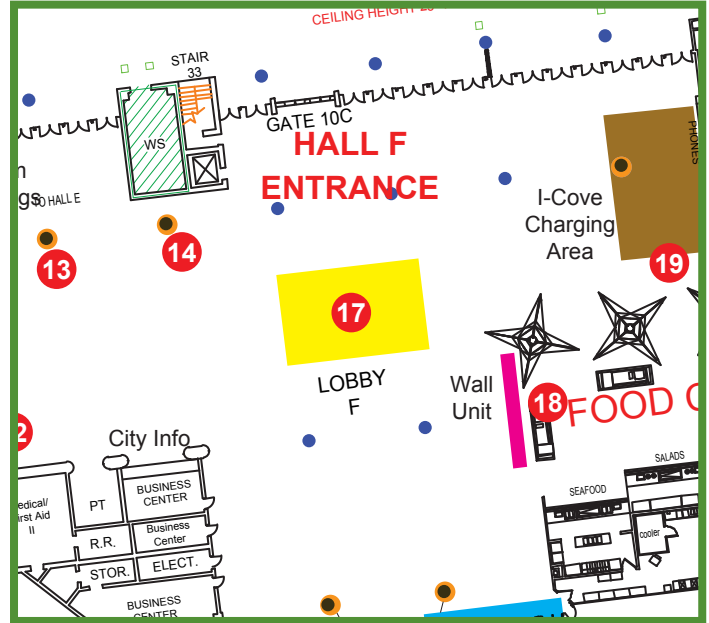
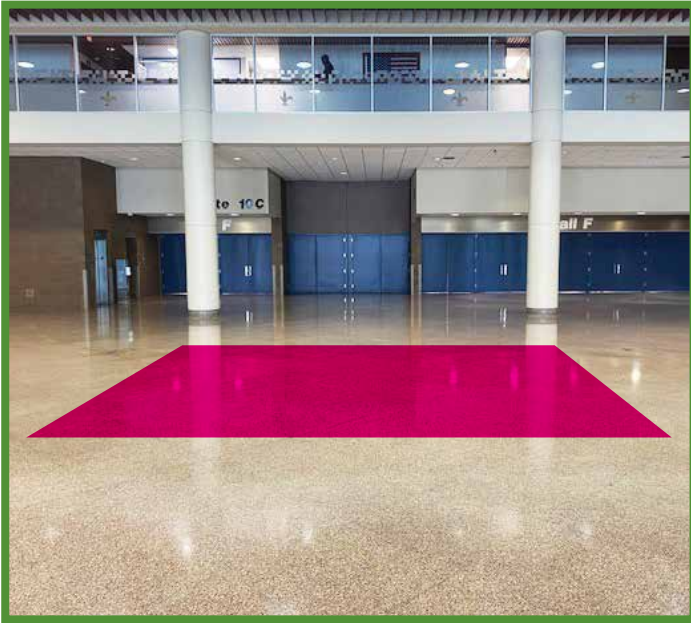

**Sponsorship Location Fee**  
Coming Soon

**Printing & Installation Fee**  
Coming Soon

### Floor Clings

Clings bigger than 50" x 50" will be tiled.

### Additional Information

Floor cling printing & installation pricing is dependent on quantity and size of clings within the given area. This floor cling location is in front of Hall F Entrance into the Trade Show.





# Wall Unit Hall F Lobby

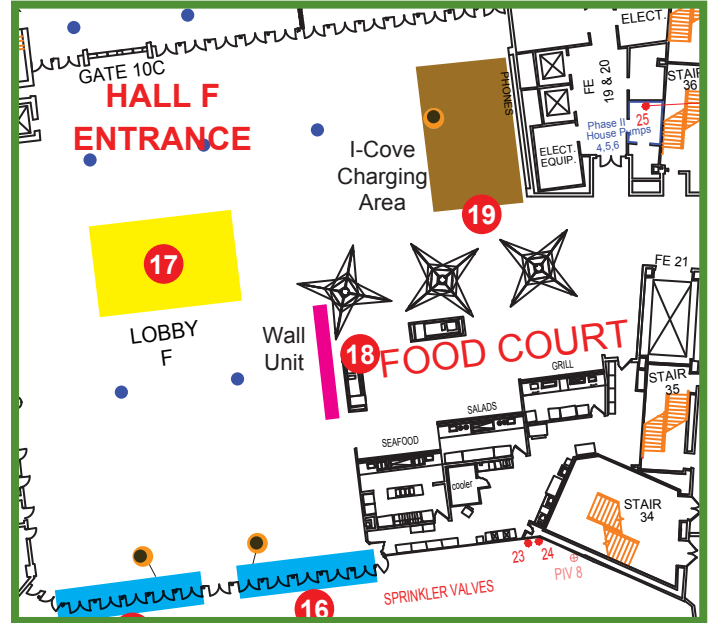

**Sponsorship Location Fee**  
Coming Soon

**Printing & Installation Fee**  
Coming Soon

## Wall Unit

12' Tall x 15' Wide

## Additional Information

This is a single-sided hard wall to be installed in front of the brown wall shown in the photo, for the sponsor to have their graphic installed.



### Column Wrap, Wall Cling & Table Clings Hall F Lobby

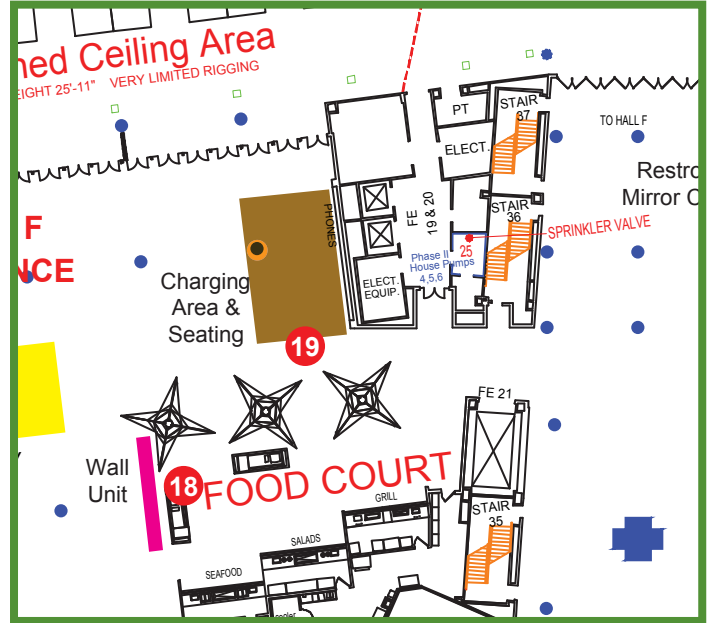

**Sponsorship Location Fee**  
Coming Soon

**Printing & Installation Fee**  
Coming Soon

#### Wall Cling

Sponsor may cling white wall above built in charging station coves.

#### Column Wrap (x1) 12' tall

Wraps will be made with agam metal (see mockup at right).

#### Table Clings

Sponsor may cling tables in this seating area.

#### Location Information

The built-in charging station and seating area next to Trade Show Hall F entrance.

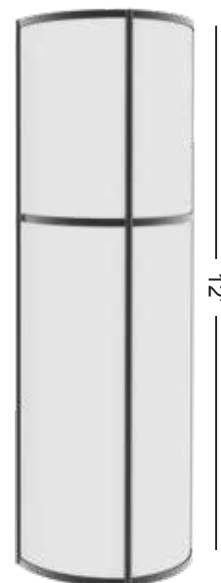



# Restroom Mirror Clings Hall G Lobby

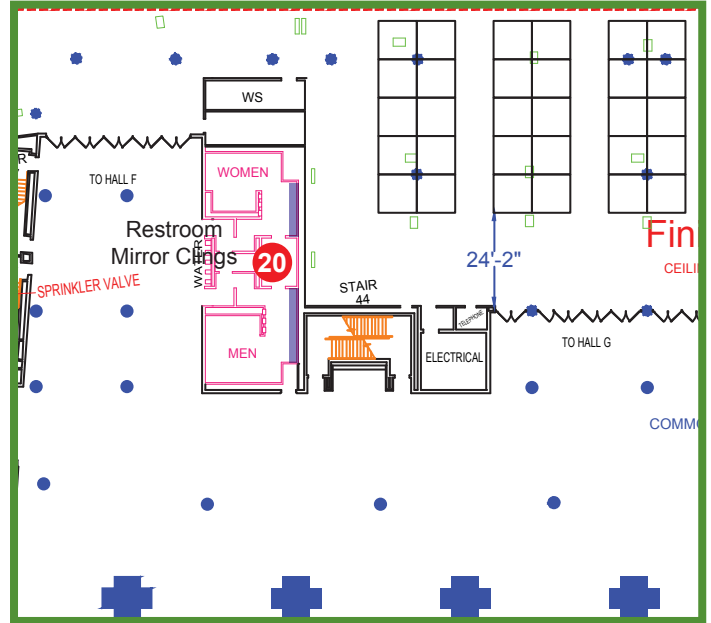

**Sponsorship Location Fee**  
Coming Soon

**Printing & Installation Fee**  
Coming Soon

**Mirror Clings** 16" x 16"

Clings placed on lower right corner of mirrors.  
(3-4 mirrors per restroom)

**Additional Information**

This opportunity includes the Men's and Women's restrooms in this location.



## Streetcar Bar Branding with Floor Cling & Column Wraps Hall G Lobby

OPPORTUNITY #21

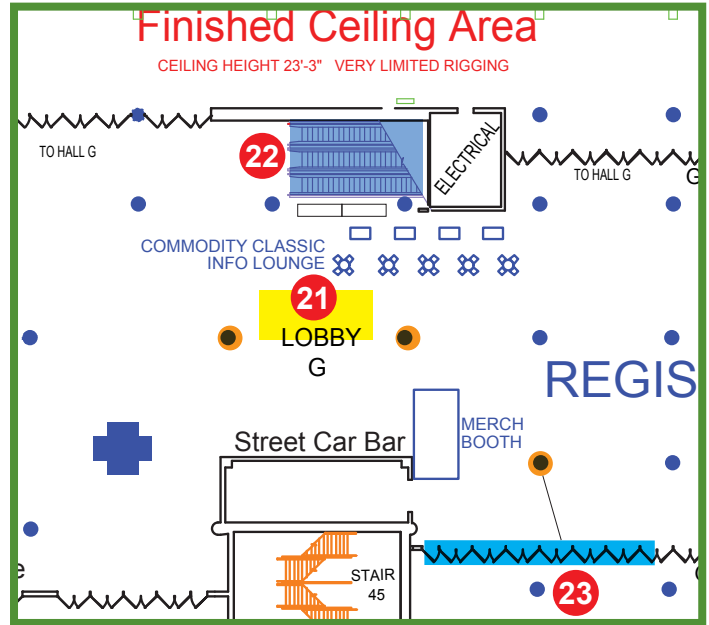

**Sponsorship Location Fee**  
Coming Soon

**Printing & Installation Fee**  
Coming Soon

### Floor Clings

Clings bigger than 50" x 50" will be tiled.

### Column Wraps (x2) 16' tall

Wraps will be made with agam metal (see mockup at right)

### Additional Information

Next to Streetcar Bar concession stand and Commodity Classic info counters. Tables and chairs shown in photo will not be placed on your floor clings.

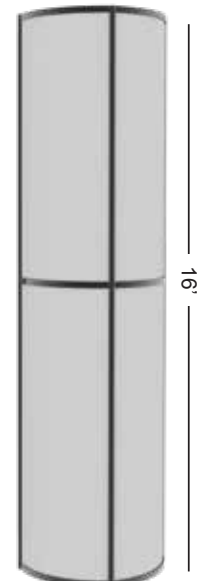



# Escalator Clings Hall G Lobby

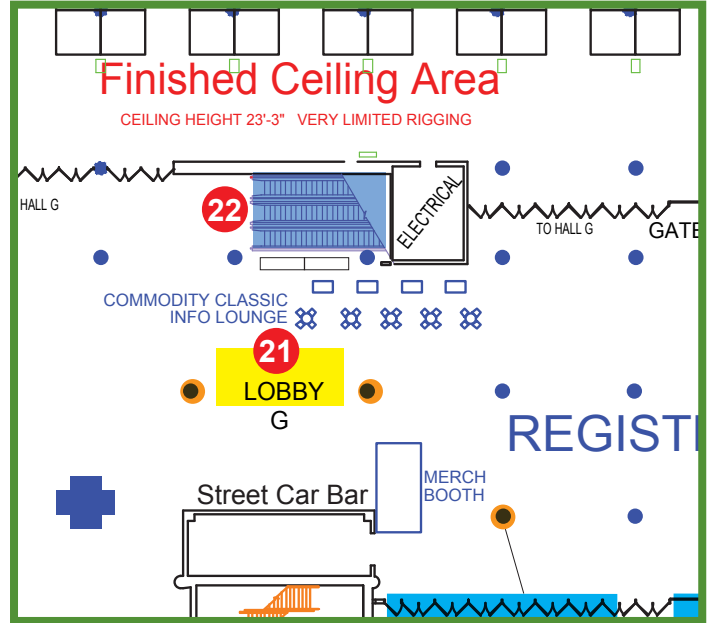

**Sponsorship Location Fee**  
Coming Soon

**Printing & Installation Fee**  
Coming Soon

## Escalator Clings

Metal Sides: 58' x 23.5" (x6)  
Flat Divider: 11.5" x 71' (x2)

## Additional Information

Escalator goes up to Education Sessions, General Session, and Association Meetings.

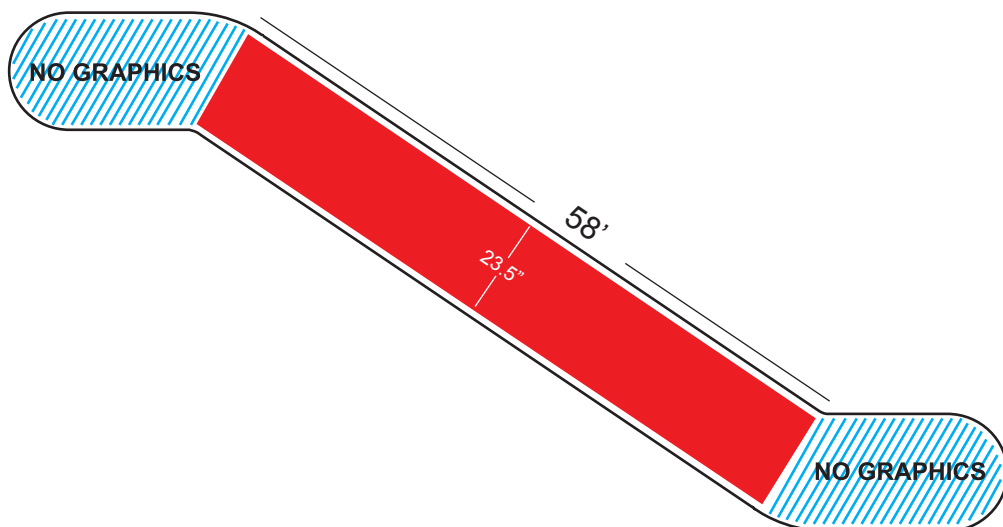



# Window Clings & Column Wrap

## Hall G Lobby Registration

Inside facing Clings

OPPORTUNITY #23

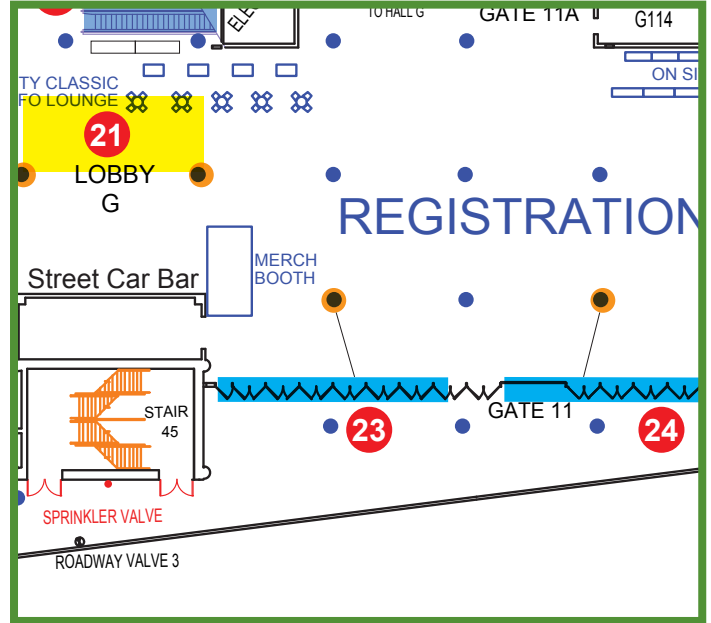

**Sponsorship Location Fee**  
Coming Soon

**Printing & Installation Fee**  
Coming Soon

### Window Clings

- A: 88" x 70.25" (x7)
- B: 88" x 27.875" (x7)
- C: 88" x 59.875" (x7)
- D: 35.25" x 34.5" (x15)
- F: 44.5" x 70.25" (x1)
- G: 44.5" x 27.875" (x1)
- H: 44.5" x 59.875" (x1)
- I: 25" x 70.25" (x1)
- J: 25" x 27.875" (x1)
- K: 25" x 59.875" (x1)
- L: 25" x 90" (x1)

### Column Wrap (x1) 16' tall

Wraps will be made with agam metal (see mockup below)

A <sub>5</sub> No Graphics	A <sub>6</sub>	A <sub>7</sub>	A <sub>8</sub>	A <sub>9</sub>	A <sub>10</sub>	A <sub>11</sub>	A <sub>12</sub>	F <sub>1</sub>	I <sub>1</sub>
	B <sub>6</sub>	B <sub>7</sub>	B <sub>8</sub>	B <sub>9</sub>	B <sub>10</sub>	B <sub>11</sub>	B <sub>12</sub>	G <sub>1</sub>	J <sub>1</sub>
C <sub>5</sub>	C <sub>6</sub>	C <sub>7</sub>	C <sub>8</sub>	C <sub>9</sub>	C <sub>10</sub>	C <sub>11</sub>	C <sub>12</sub>	H <sub>1</sub>	K <sub>1</sub>
D <sub>9</sub> D <sub>11</sub> No Graphics	No Graphics Above Door Handles								L <sub>1</sub>
	D <sub>11</sub> D <sub>12</sub>	D <sub>13</sub> D <sub>14</sub>	D <sub>15</sub> D <sub>16</sub>	D <sub>17</sub> D <sub>18</sub>	D <sub>19</sub> D <sub>20</sub>	D <sub>21</sub> D <sub>22</sub>	D <sub>23</sub> D <sub>24</sub>	D <sub>25</sub>	

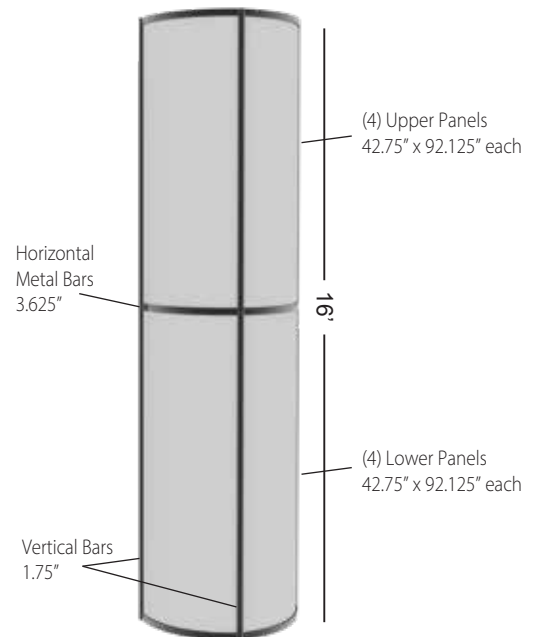



# Window Clings & Column Wrap

## Hall G Lobby Registration

Inside facing Clings

OPPORTUNITY #24

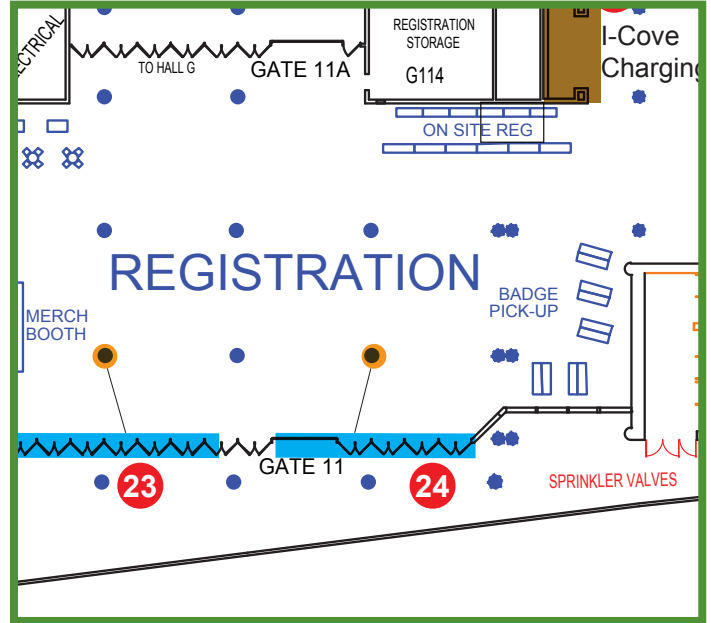

**Sponsorship Location Fee**  
Coming Soon

**Printing & Installation Fee**  
Coming Soon

### Window Clings

- A: 88" x 70.25" (x4)
- B: 88" x 27.875" (x4)
- C: 88" x 59.875" (x4)
- D: 35.25" x 34.5" (x8)
- E: 86.375" x 70.25" (x2)
- M: 36" x 16.5" (x4)
- N: 40.5" x 16.5" (x4)
- O: 36" x 18.625" (x4)
- P: 40.5" x 18.625" (x4)
- Q: 36" x 21.5" (x8)
- R: 40.5" x 21.5" (x8)

A <sub>1</sub>	A <sub>2</sub>	A <sub>3</sub>	A <sub>4</sub>	E <sub>1</sub>	E <sub>2</sub>		
B <sub>1</sub>	B <sub>2</sub>	B <sub>3</sub>	B <sub>4</sub>	No Graphics			
C <sub>1</sub>	C <sub>2</sub>	C <sub>3</sub>	C <sub>4</sub>	M <sub>1</sub>	N <sub>1</sub>	N <sub>2</sub>	M <sub>2</sub>
				O <sub>1</sub>	P <sub>1</sub>	P <sub>2</sub>	O <sub>2</sub>
No Graphics Above Door Handles				O <sub>3</sub>	P <sub>3</sub>	P <sub>4</sub>	O <sub>4</sub>
				Q <sub>1</sub>	R <sub>1</sub>	R <sub>2</sub>	Q <sub>2</sub>
				Q <sub>3</sub>	R <sub>3</sub>	R <sub>4</sub>	Q <sub>4</sub>
				Q <sub>5</sub>	R <sub>5</sub>	R <sub>6</sub>	Q <sub>6</sub>
D <sub>1</sub>	D <sub>2</sub>	D <sub>3</sub>	D <sub>4</sub>	D <sub>5</sub>	D <sub>6</sub>	D <sub>7</sub>	D <sub>8</sub>
				Q <sub>7</sub>	R <sub>7</sub>	R <sub>8</sub>	Q <sub>8</sub>
				M <sub>3</sub>	N <sub>3</sub>	N <sub>4</sub>	M <sub>4</sub>

### Column Wrap (x1) 16' tall

Wraps will be made with agam metal (see mockup below)

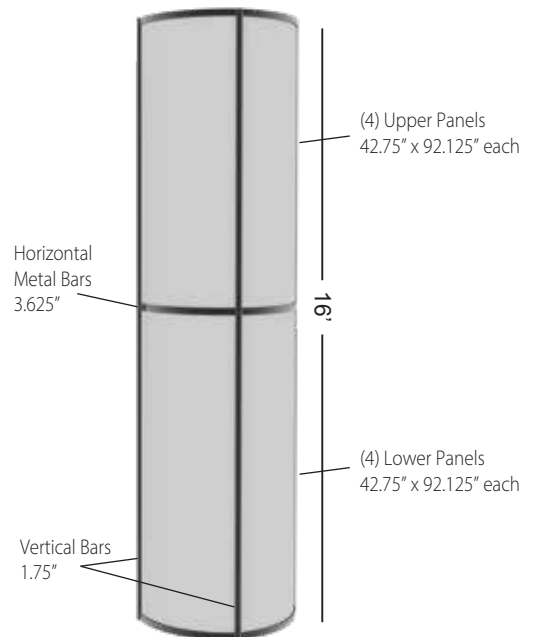



# I-Cove Charging Area, Wall Cling Hall H Entrance

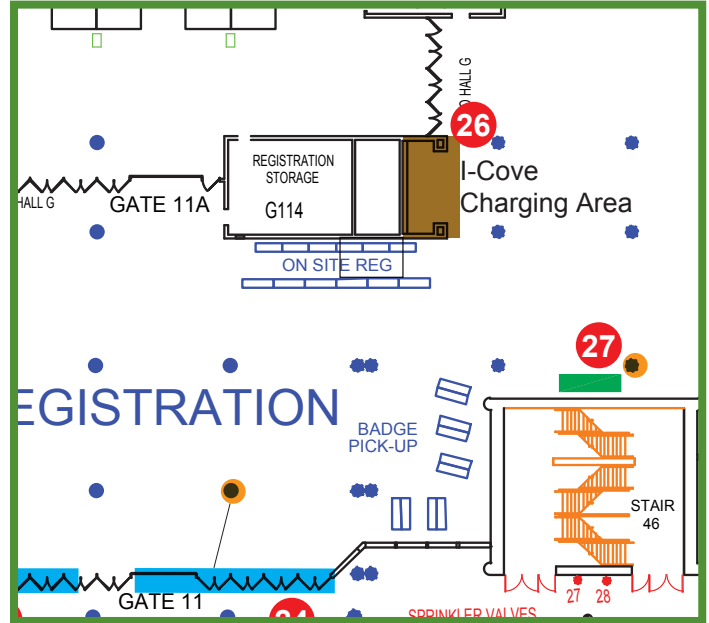

**Sponsorship Location Fee**  
Coming Soon

**Printing & Installation Fee**  
Coming Soon

## Wall Cling

Sponsor may cling white wall above I-Cove.

## Additional Information

I-Cove is a built-in charging station next to Trade Show Hall H Entrance.



### Banner Hall H Lobby

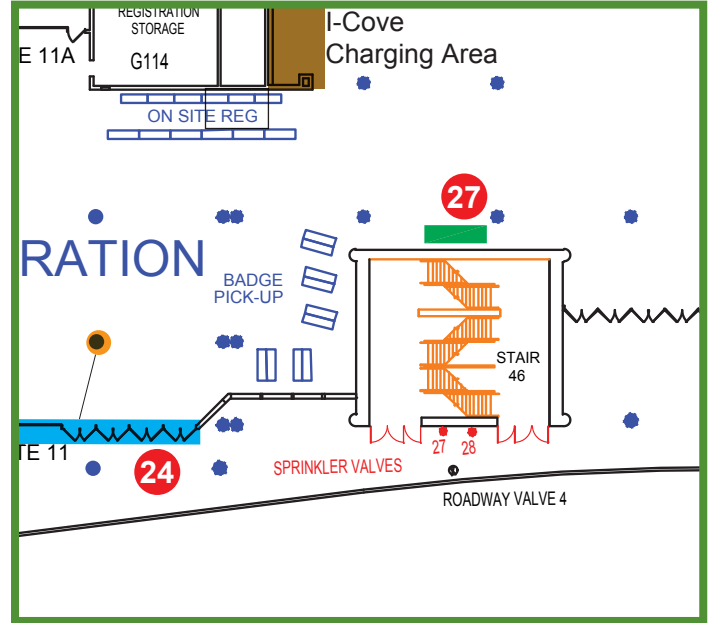

**Sponsorship Location Fee**  
Coming Soon

**Printing & Installation Fee**  
Coming Soon

**Banner** (x1) 20' x 16'

Single sided banner hung off velour drape.

### Additional Information

Banner located across from Hall H Entrance



240"

192"



# Window Clings Hall H Lobby

Inside facing

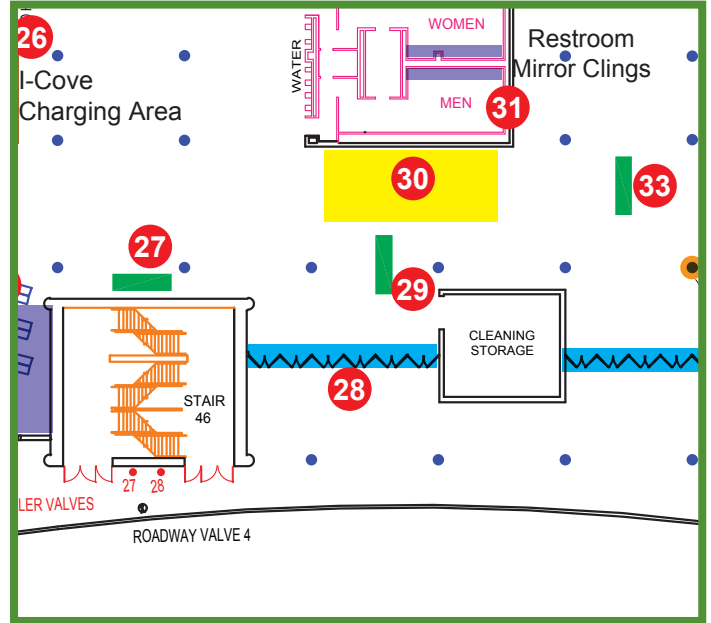

**Sponsorship Location Fee**  
Coming Soon

**Printing & Installation Fee**  
Coming Soon

## Window Clings

- A: 87.5" x 70.25" (x3)      E: 90" x 70.25" (x3)
- B: 87.5" x 27.875" (x3)    F: 90" x 27.875" (x3)
- C: 87.5" x 59.875" (x3)    G: 90" x 59.875" (x3)
- D: 34.875" x 34.5" (x12)

A <sub>1</sub>	A <sub>2</sub>	A <sub>3</sub>	E <sub>1</sub>	E <sub>2</sub>	E <sub>3</sub>						
B <sub>1</sub>	B <sub>2</sub>	B <sub>3</sub>	F <sub>1</sub>	F <sub>2</sub>	F <sub>3</sub>						
C <sub>1</sub>	C <sub>2</sub>	C <sub>3</sub>	G <sub>1</sub>	G <sub>2</sub>	G <sub>3</sub>						
No Graphics Above Door Handles											
D <sub>1</sub>	D <sub>2</sub>	D <sub>3</sub>	D <sub>4</sub>	D <sub>5</sub>	D <sub>6</sub>	D <sub>7</sub>	D <sub>8</sub>	D <sub>9</sub>	D <sub>10</sub>	D <sub>11</sub>	D <sub>12</sub>



# Hanging Banner Hall H Lobby

Double Sided

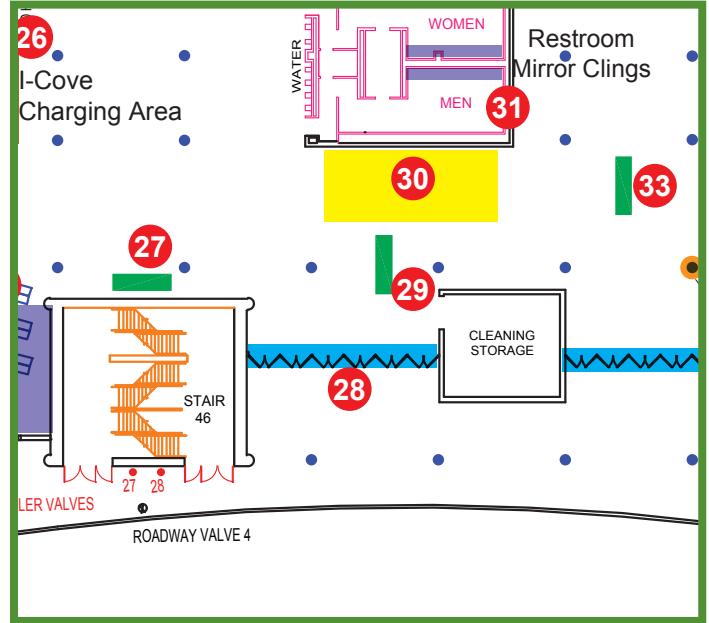

**Sponsorship Location Fee**  
Coming Soon

**Printing & Installation Fee**  
Coming Soon

## Hanging Banner

120" x 96"



120"

96"



# Floor Cling Hall H Lobby

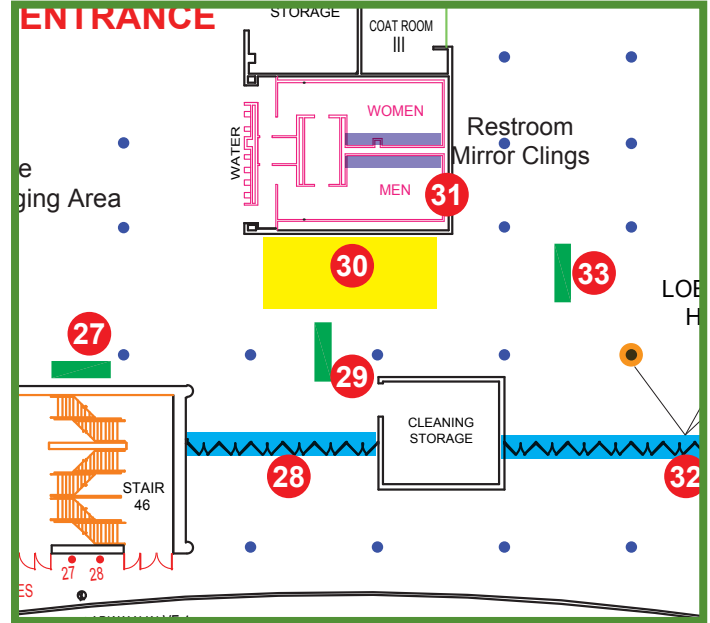

**Sponsorship Location Fee**  
Coming Soon

**Printing & Installation Fee**  
Coming Soon

## Floor Cling

Clings bigger than 50" x 50" will be tiled.

## Additional Information

Floor cling printing & installation pricing is dependent on quantity and size of clings within the given area. Next to Hall H Entrance





# Restroom Mirror Clings Hall H Lobby



**Sponsorship Location Fee**  
Coming Soon

**Printing & Installation Fee**  
Coming Soon

**Mirror Clings** 16" x 16"

Clings placed on lower right corner of mirrors.  
(3-4 mirrors per restroom)

**Additional Information**

This opportunity includes the Men's and Women's restrooms in this location.



## Window Clings, Banner & Column Wraps Hall H Lobby

Inside facing

OPPORTUNITY #32

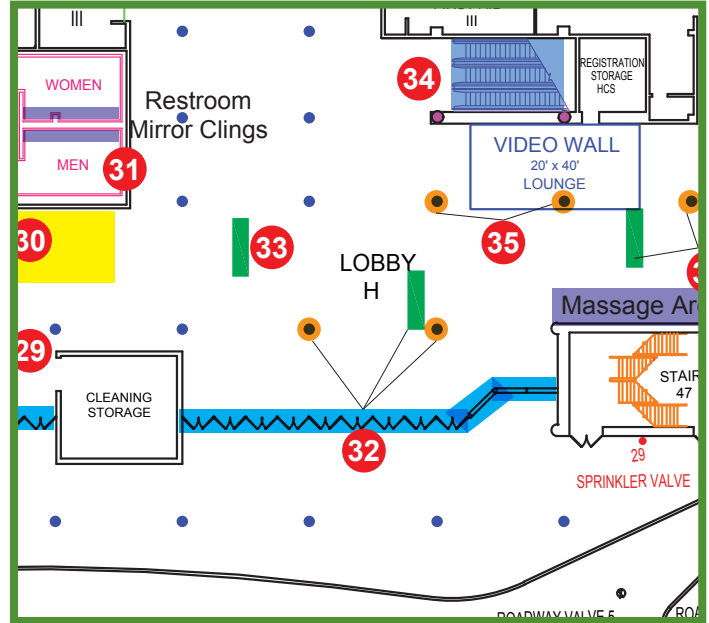

**Sponsorship Location Fee**  
Coming Soon

**Printing & Installation Fee**  
Coming Soon

### Window Clings

- A: 88" x 70.25" (x9)
- B: 88" x 27.875" (x9)
- C: 88" x 59.875" (x9)
- D: 82.5" x 70.25" (x1)
- E: 82.5" x 27.875" (x1)
- F: 82.5" x 59.875" (x1)
- G: 83" x 70.25" (x1)
- H: 83" x 27.875" (x1)
- I: 83" x 59.875" (x1)
- J: 91.5" x 70.25" (x1)
- K: 91.5" x 27.875" (x1)
- L: 91.5" x 59.875" (x1)
- M: 82.5" x 90" (x1)
- N: 83" x 90" (x1)
- O: 91.5" x 90" (x1)
- P: 34.875" x 34.5" (x18)

### Hanging Banner

120" x 96" Double Sided

### Column Wraps (x2) 16' tall

Wraps will be made with agam metal (see mockup below)

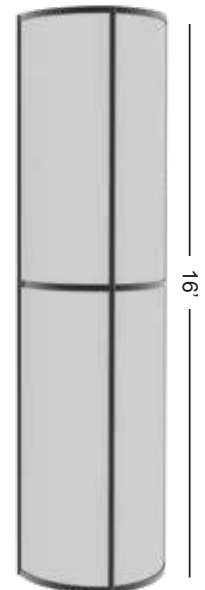

D <sub>1</sub>	G <sub>1</sub>	J <sub>1</sub>	A <sub>1</sub>	A <sub>2</sub>	A <sub>3</sub>	A <sub>4</sub>	A <sub>5</sub>	A <sub>6</sub>	A <sub>7</sub>	A <sub>8</sub>	A <sub>9</sub>									
E <sub>1</sub>	H <sub>1</sub>	K <sub>1</sub>	B <sub>1</sub>	B <sub>2</sub>	B <sub>3</sub>	B <sub>4</sub>	B <sub>5</sub>	B <sub>6</sub>	B <sub>7</sub>	B <sub>8</sub>	B <sub>9</sub>									
F <sub>1</sub>	I <sub>1</sub>	L <sub>1</sub>	C <sub>1</sub>	C <sub>2</sub>	C <sub>3</sub>	C <sub>4</sub>	C <sub>5</sub>	C <sub>6</sub>	C <sub>7</sub>	C <sub>8</sub>	C <sub>9</sub>									
			No Graphics Above Door Handles																	
M <sub>1</sub>	N <sub>1</sub>	O <sub>1</sub>	P <sub>1</sub>	P <sub>2</sub>	P <sub>3</sub>	P <sub>4</sub>	P <sub>5</sub>	P <sub>6</sub>	P <sub>7</sub>	P <sub>8</sub>	P <sub>9</sub>	P <sub>10</sub>	P <sub>11</sub>	P <sub>12</sub>	P <sub>13</sub>	P <sub>14</sub>	P <sub>15</sub>	P <sub>16</sub>	P <sub>17</sub>	P <sub>18</sub>



### Hanging Banner Hall H Lobby Double Sided

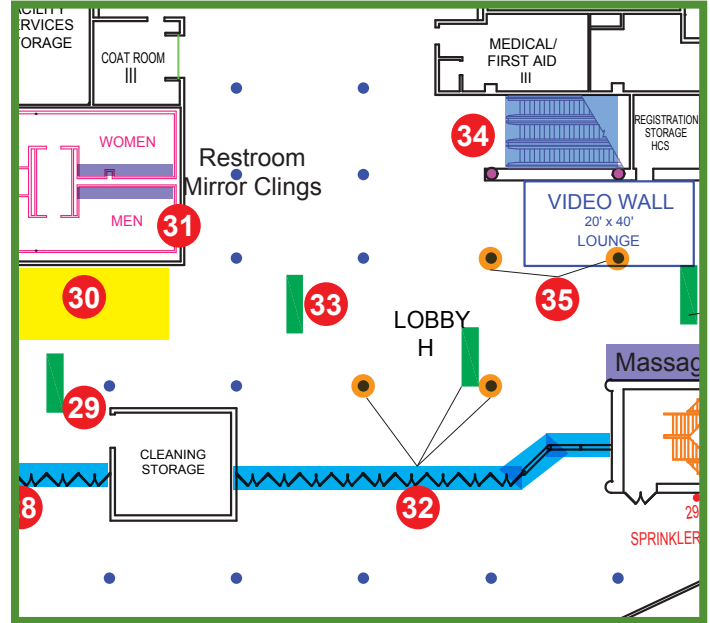

**Sponsorship Location Fee**  
Coming Soon

**Printing & Installation Fee**  
Coming Soon

### Hanging Banner

120" x 96"





# Escalator Clings Hall H Lobby

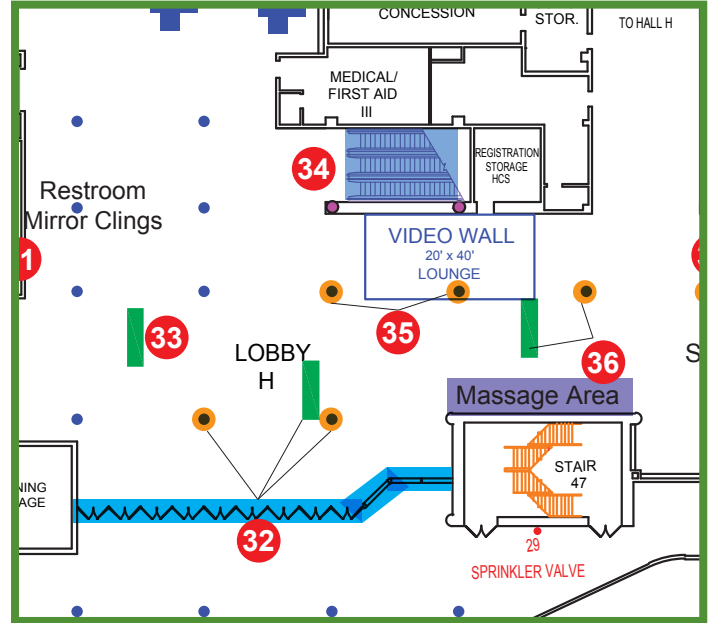

**Sponsorship Location Fee**  
Coming Soon

**Printing & Installation Fee**  
Coming Soon

## Escalator Clings

Metal Sides: 58' x 23.5" (x6)  
Flat Divider: 11.5" x 71' (x2)

## Additional Information

Escalator goes up to Education Sessions, General Session, Association Meetings.

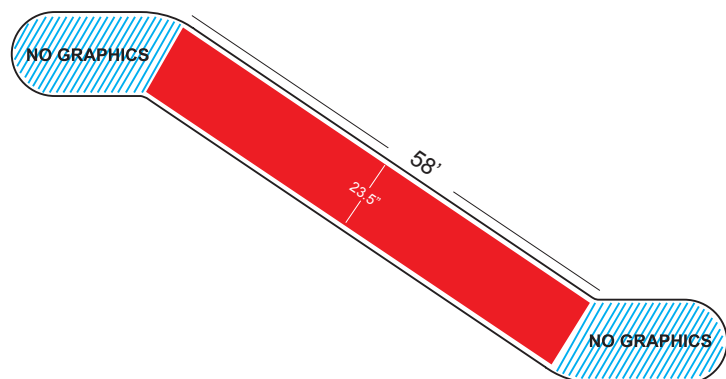



# Video Wall, Lounge Seating & 2 Column Wraps

## Hall H Lobby

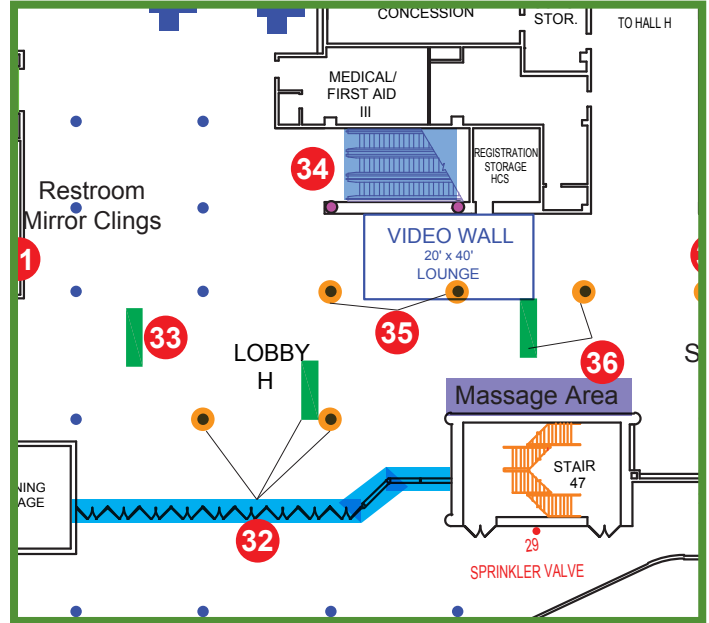

**Sponsorship Location Fee**  
Coming Soon

**Printing & Installation Fee**  
Coming Soon

### Column Wraps (x1) 16' tall

Wraps will be made with agam metal (see mockup at right)

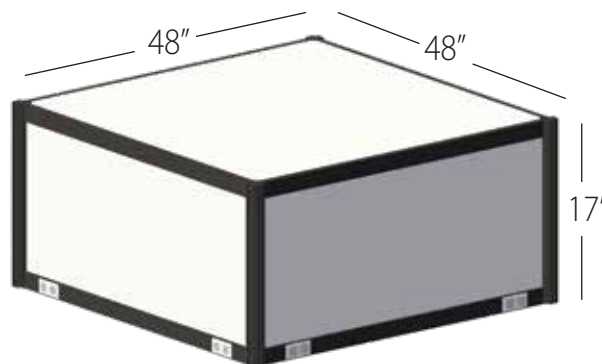
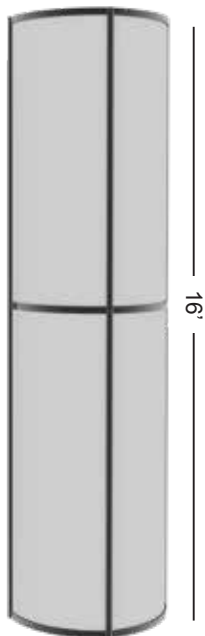

### Additional Information

Soft seating and coffee tables will be installed here for Commodity Classic guests to rest. Opportunity includes two 4'x4' lighted coffee table cubes with your company branding installed on the top surface and all four sides. Each coffee table will have outlets on the sides for guests to use.



### Massage Area, Banner & Column Wrap Hall H Lobby

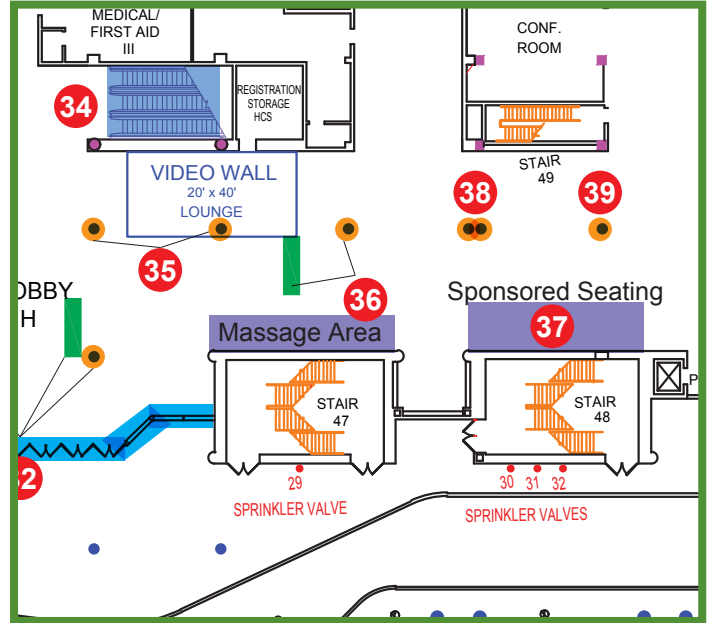

**Sponsorship Location Fee**  
Coming Soon

**Printing & Installation Fee**  
Coming Soon

### Massage Area

Associate your brand with rest and relaxation, generate outstanding visibility and be a hero to attendees as they queue up for complimentary shoulder and foot massages. Certified massage therapists provide 10-minute upper body massages in specially designed chairs during designated hours. Foot massage devices are available for attendees to use as they wait for their upper body massage. Sponsorship fee includes massage therapists and all equipment needed, as well as the opportunity to brand one column wrap and banner (printing & installation costs apply) in the walkway next to the Massage Area.

### Hanging Banner

Coming Soon

### Column Wraps (x1) 16' tall

Wraps will be made with agam metal (see mockup at right)

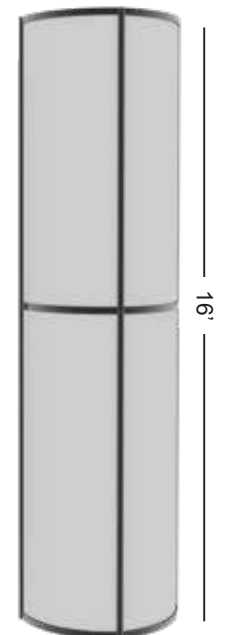



### Lounge Seating Hall H Lobby

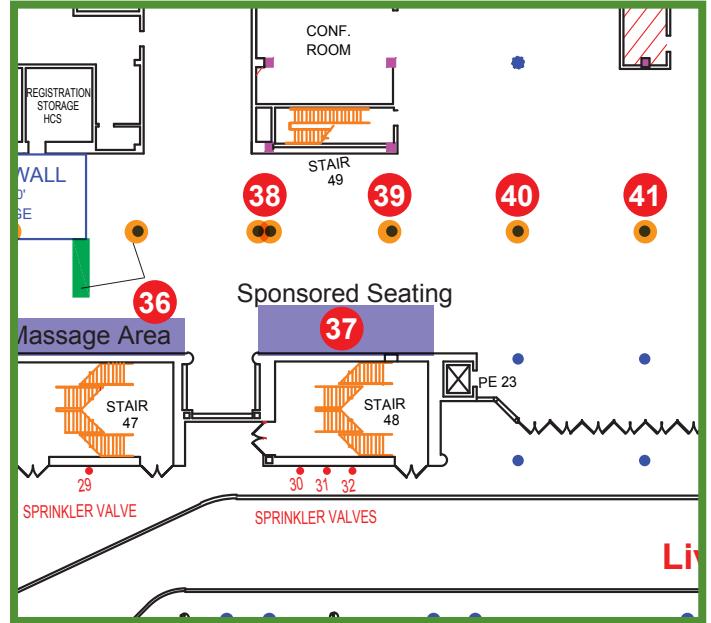

**Sponsorship Location Fee**  
Coming Soon

**Printing & Installation Fee**  
Coming Soon

### Sponsored Seating

Soft seating and coffee tables will be installed here for Commodity Classic guests to rest and relax. Opportunity includes two 4'x4' lighted coffee table cubes with your company branding installed on the top surface and all four sides. Each coffee table will have outlets on the sides for guests to use.

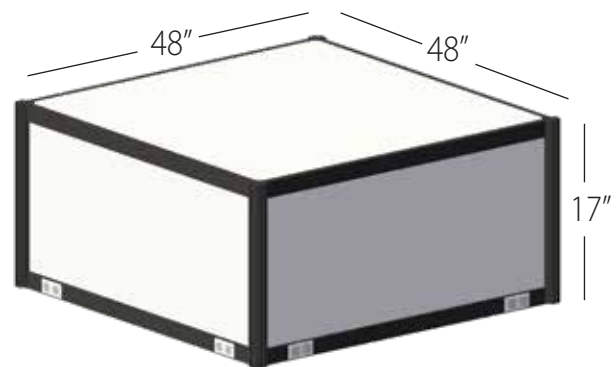



### Column Wrap Hall H Lobby

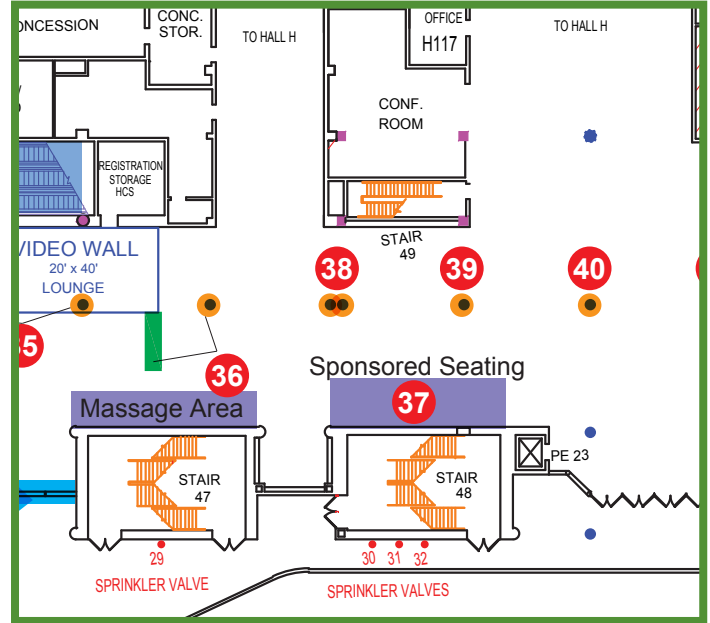
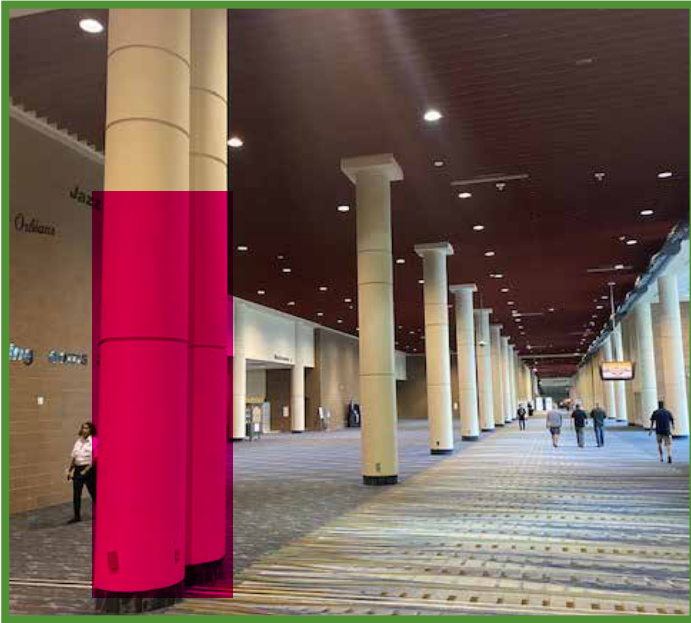

**Sponsorship Location Fee**  
Coming Soon

**Printing & Installation Fee**  
Coming Soon

#### Column Wraps (x1) 16' tall

Wraps will be made with agam metal (see mockup below)

#### Additional Information

This opportunity consists of two connected columns. Please note that the width to encircle this "double column" is wider than the other columns offered.

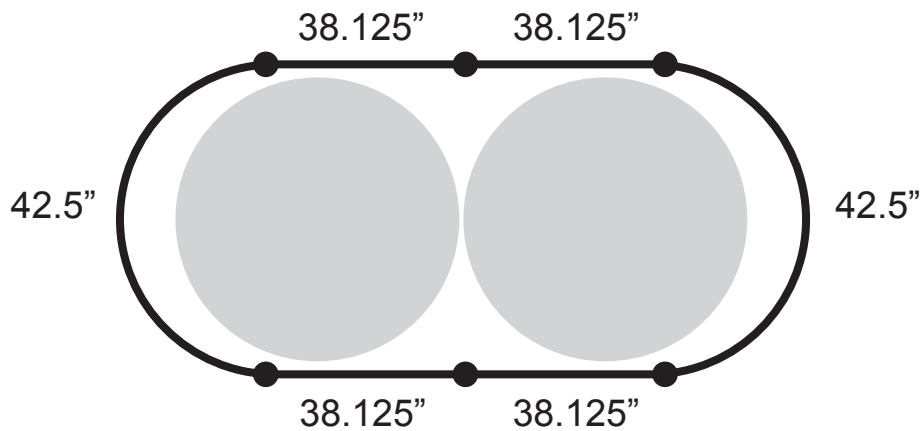



# Column Wrap Hall H Lobby

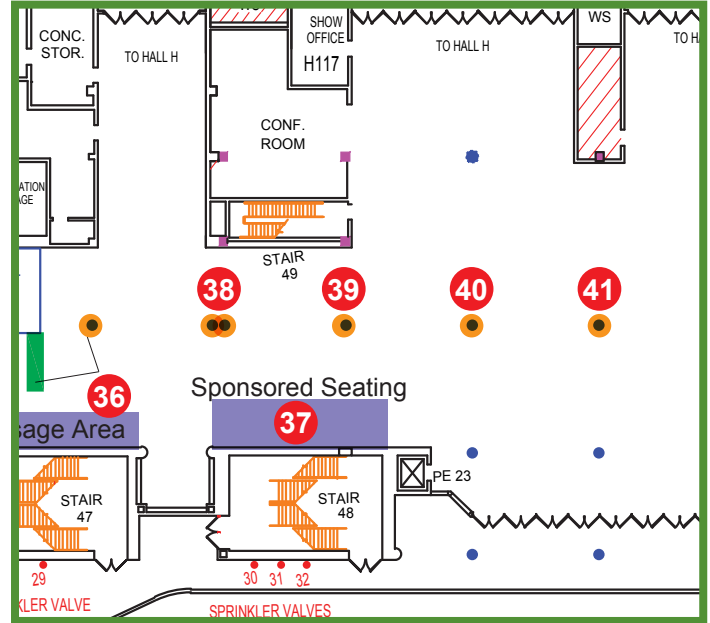

**Sponsorship Location Fee**  
Coming Soon

**Printing & Installation Fee**  
Coming Soon

## Column Wrap (x1) 16' tall

Wraps will be made with agam metal  
(see mockup at right)

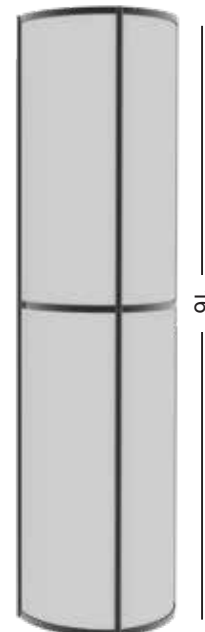



# Column Wrap Hall I Lobby

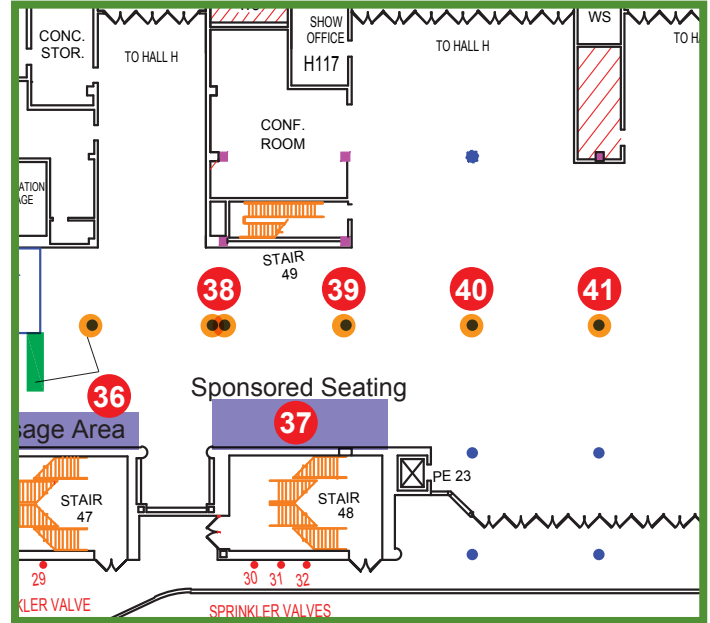

**Sponsorship Location Fee**  
Coming Soon

**Printing & Installation Fee**  
Coming Soon

## Column Wrap (x1) 16' tall

Wraps will be made with agam metal  
(see mockup at right)

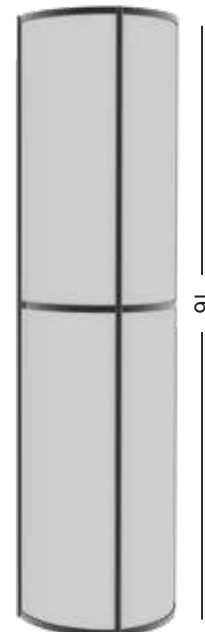



# Column Wrap Hall I Lobby

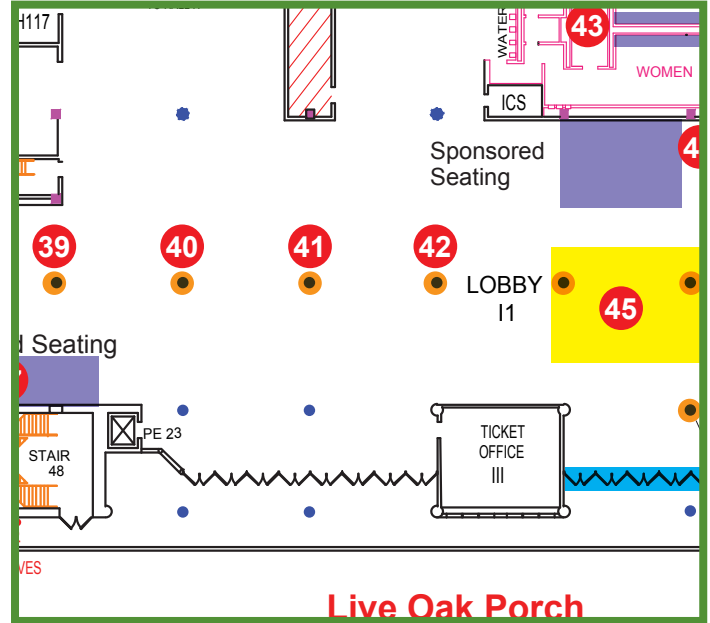

**Sponsorship Location Fee**  
Coming Soon

**Printing & Installation Fee**  
Coming Soon

**Column Wrap** (x1) 16' tall

Wraps will be made with agam metal  
(see mockup at right)

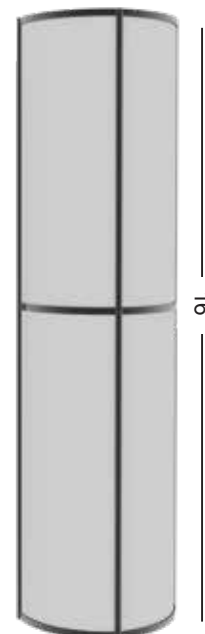



# Column Wrap Hall I Lobby

OPPORTUNITY #42

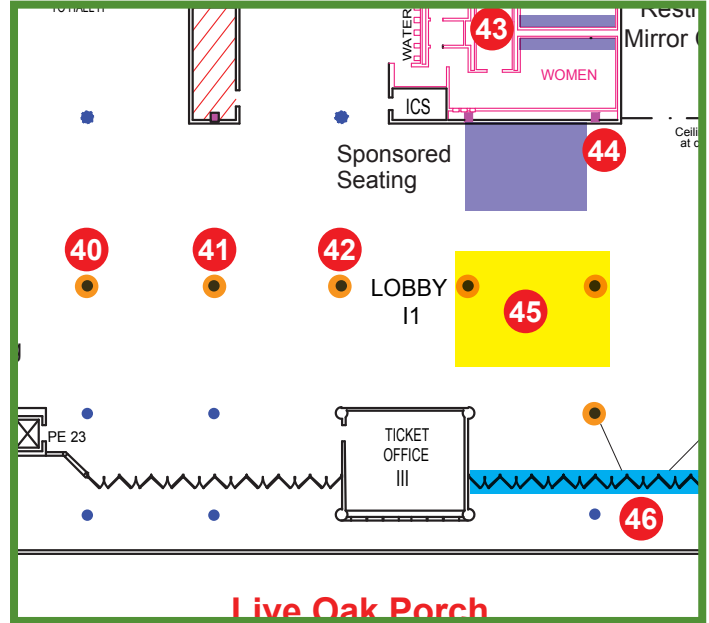

**Sponsorship Location Fee**  
Coming Soon

**Printing & Installation Fee**  
Coming Soon

**Column Wrap** (x1) 16' tall

Wraps will be made with agam metal  
(see mockup at right)

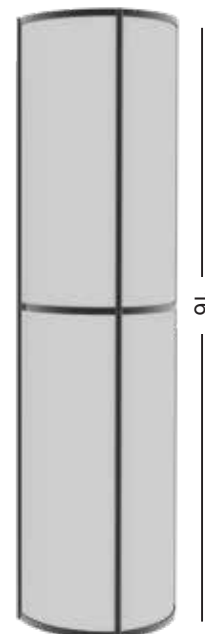



# Restroom Mirror Clings Hall I Lobby

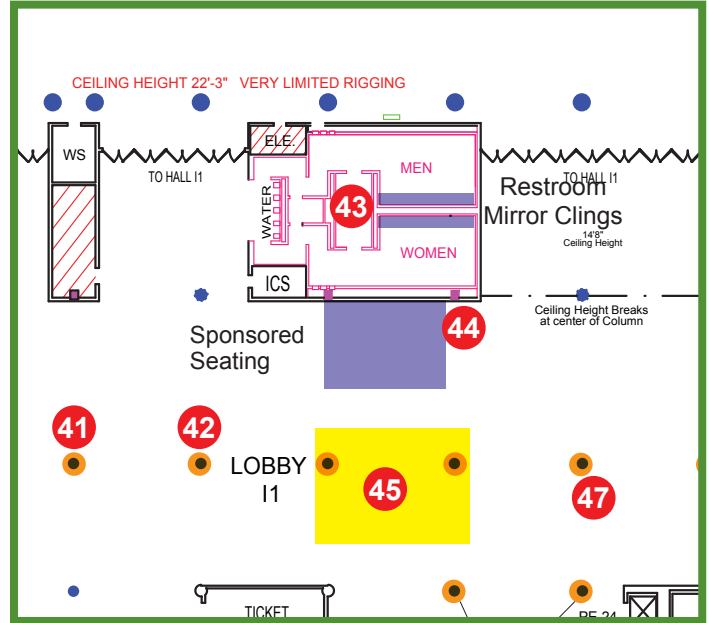

**Sponsorship Location Fee**  
Coming Soon

**Printing & Installation Fee**  
Coming Soon

## Mirror Clings 16" x 16"

Clings placed on lower right corner of mirrors.  
(3-4 mirrors per restroom)

## Additional Information

This opportunity includes the Men's and Women's restrooms in this location.



## OPPORTUNITY #44

### Sponsored Seating Hall I Lobby

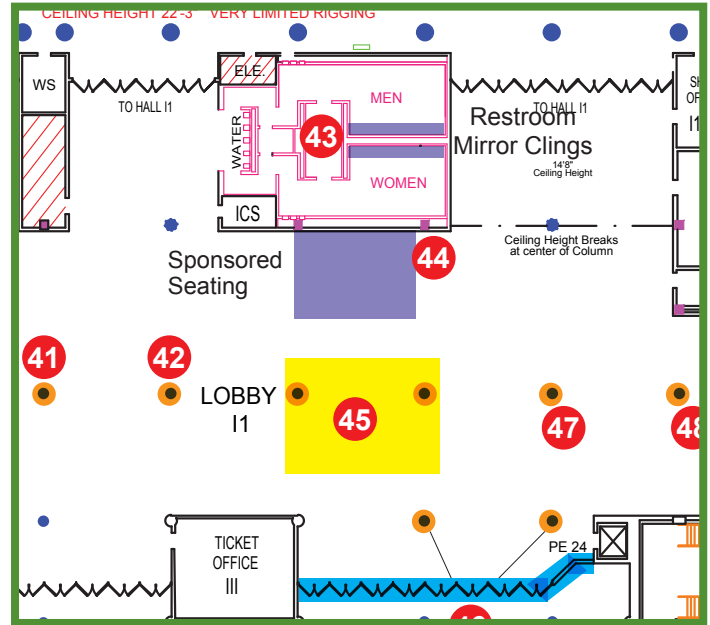

**Sponsorship Location Fee**  
Coming Soon

**Printing & Installation Fee**  
Coming Soon

### Seating Area

Soft seating and coffee tables will be installed here for Commodity Classic guests to rest. Opportunity includes two 4'x4' lighted coffee table cubes with your company branding installed on the top surface and all four sides. Each coffee table will have outlets on the sides for guests to use.

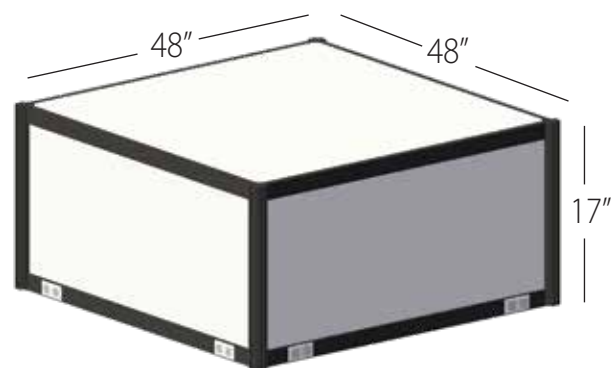



## Floor Cling & Column Wraps Hall I Lobby

### OPPORTUNITY #45

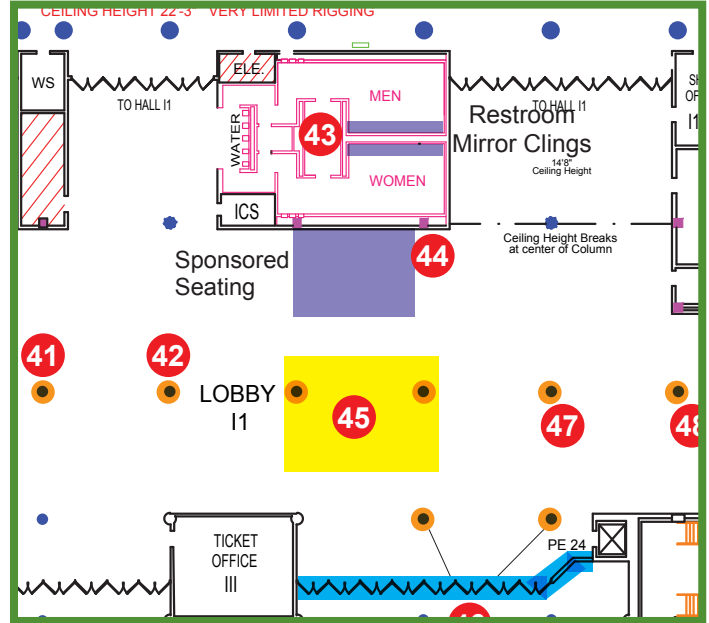

**Sponsorship Location Fee**  
Coming Soon

**Printing & Installation Fee**  
Coming Soon

### Floor Cling

Clings bigger than 50" x 50" will be tiled.

### Additional Information

Floor cling printing & installation pricing is dependent on quantity and size of clings within the given area.

### Column Wraps (x2) 16' tall

Wraps will be made with agam metal (see mockup at right)

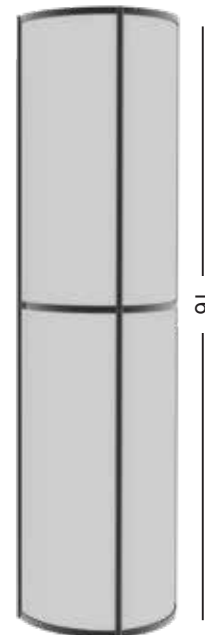



# Window Clings

## Hall I Lobby

Inside facing Clings

OPPORTUNITY #46

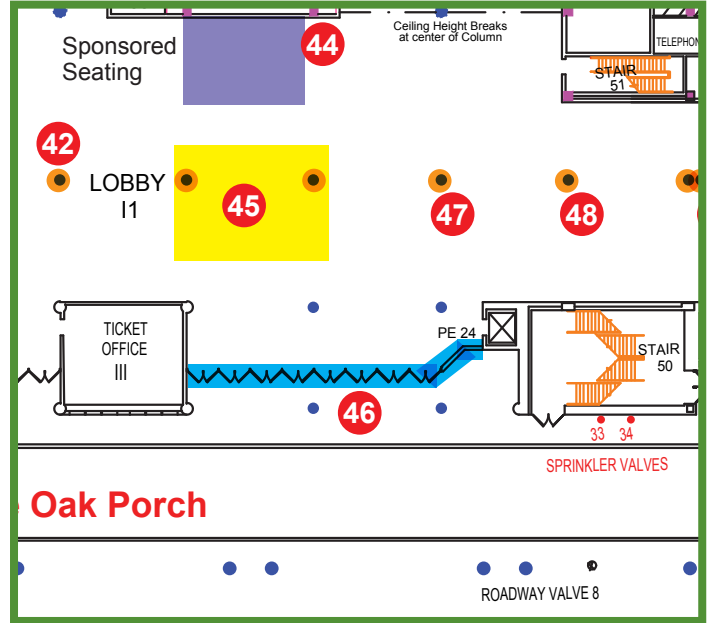

**Sponsorship Location Fee**  
Coming Soon

**Printing & Installation Fee**  
Coming Soon

### Window Clings

- A: 88" x 70.25" (x8)
- B: 88" x 27.875" (x8)
- C: 88" x 59.875" (x8)
- D: 72" x 70.25" (x1)
- E: 72" x 27.875" (x1)
- F: 72" x 59.875" (x1)
- G: 45" x 70.25" (x1)
- H: 45" x 27.875" (x1)
- I: 45" x 59.875" (x1)
- J: 72" x 90" (x1)
- K: 45" x 90" (x1)
- L: 35.25" x 34.5" (x16)

G <sub>1</sub>	D <sub>1</sub>	A <sub>1</sub>	A <sub>2</sub>	A <sub>3</sub>	A <sub>4</sub>	A <sub>5</sub>	A <sub>6</sub>	A <sub>7</sub>	A <sub>8</sub>						
	E <sub>1</sub>	B <sub>1</sub>	B <sub>2</sub>	B <sub>3</sub>	B <sub>4</sub>	B <sub>5</sub>	B <sub>6</sub>	B <sub>7</sub>	B <sub>8</sub>						
	F <sub>1</sub>	C <sub>1</sub>	C <sub>2</sub>	C <sub>3</sub>	C <sub>4</sub>	C <sub>5</sub>	C <sub>6</sub>	C <sub>7</sub>	C <sub>8</sub>						
K <sub>1</sub>	J <sub>1</sub>	No Graphics Above Door Handles													
		L <sub>1</sub>	L <sub>2</sub>	L <sub>3</sub>	L <sub>4</sub>	L <sub>5</sub>	L <sub>6</sub>	L <sub>7</sub>	L <sub>8</sub>	L <sub>9</sub>	L <sub>10</sub>	L <sub>11</sub>	L <sub>12</sub>	L <sub>13</sub>	L <sub>14</sub>



# Column Wrap Hall I Lobby

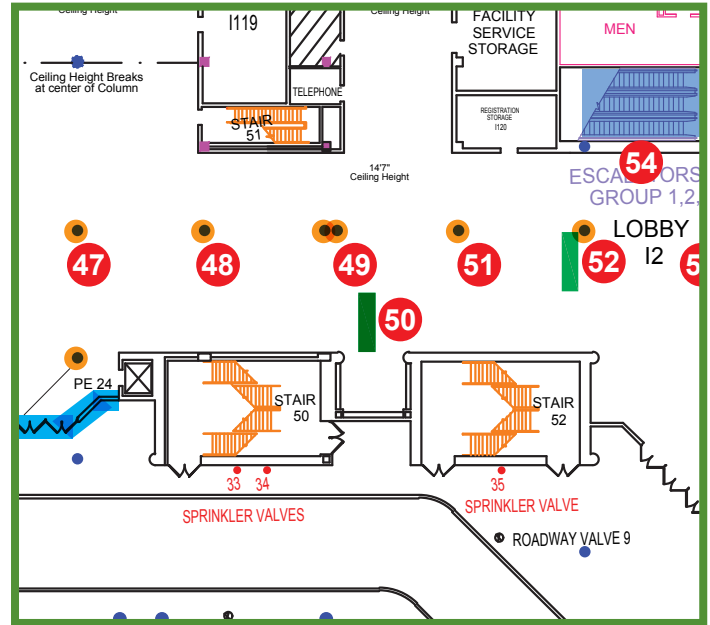

**Sponsorship Location Fee**  
Coming Soon

**Printing & Installation Fee**  
Coming Soon

## Column Wrap 16' tall

Wrap will be made with agam metal  
(see mockup at right)

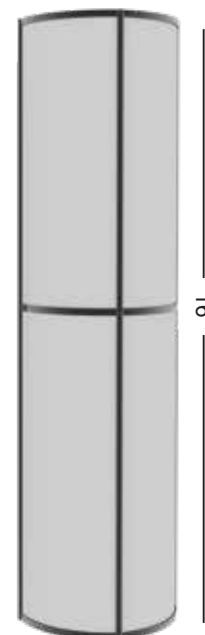



### Column Wrap Hall I Lobby

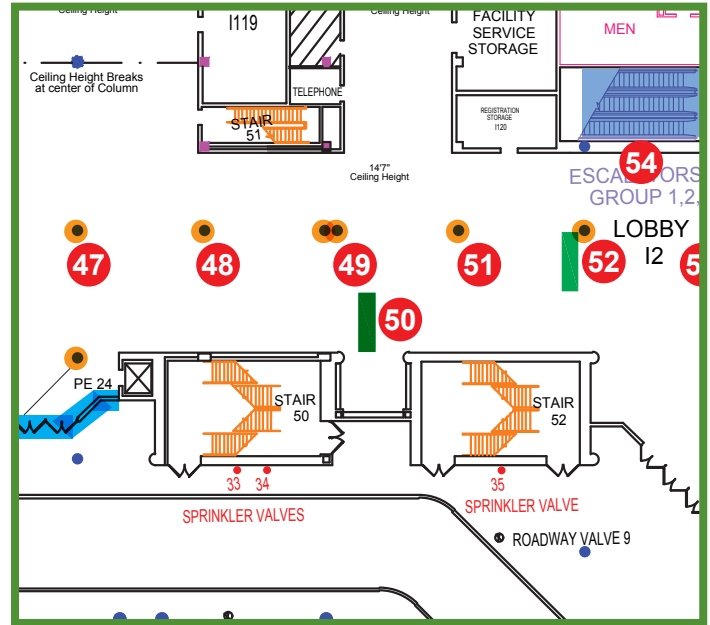

**Sponsorship Location Fee**  
Coming Soon

**Printing & Installation Fee**  
Coming Soon

#### Column Wrap 16' tall

Wrap will be made with agam metal  
(see mockup at right)

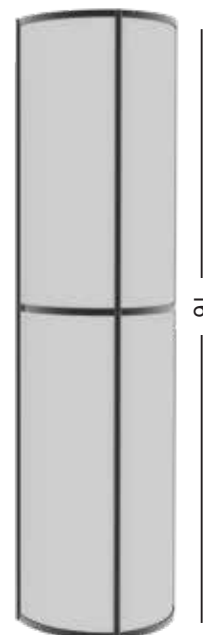



# Column Wrap Hall H Lobby

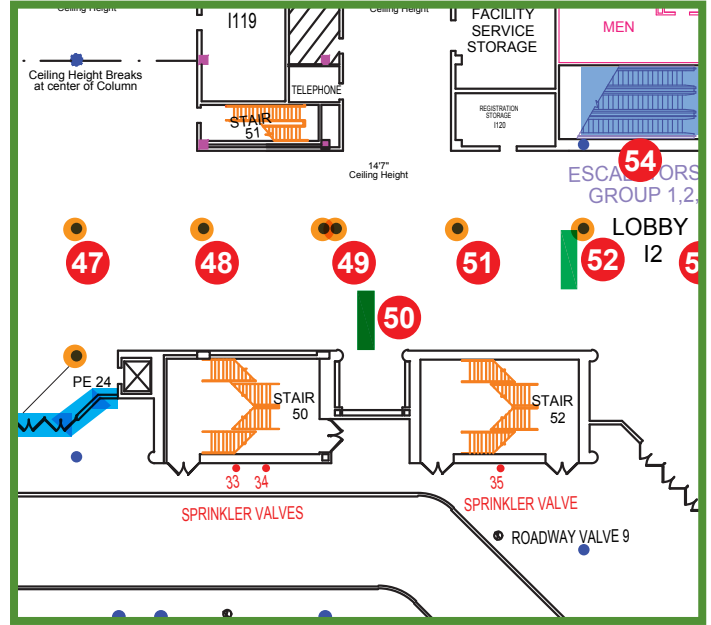
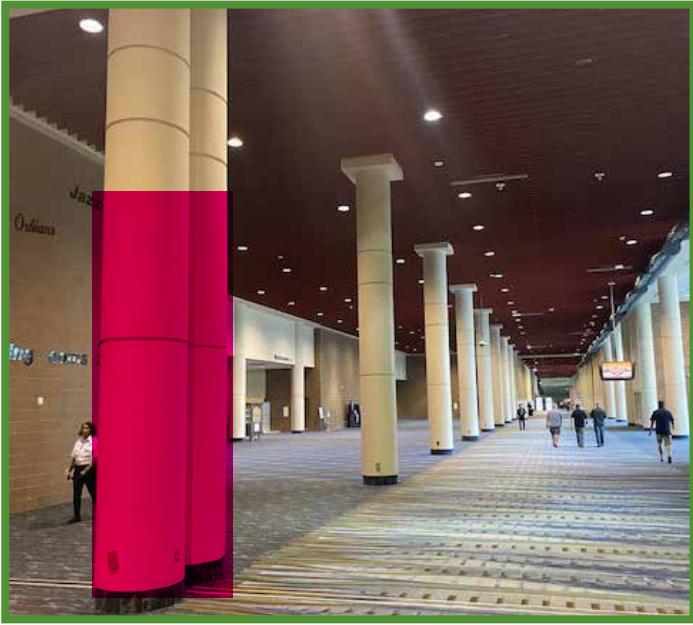

**Sponsorship Location Fee**  
Coming Soon

**Printing & Installation Fee**  
Coming Soon

## Column Wraps (x1) 16' tall

Wraps will be made with agam metal (see mockup below)

## Additional Information

This opportunity consists of two connected columns. Please note that the width to encircle this "double column" is wider than the other columns offered.

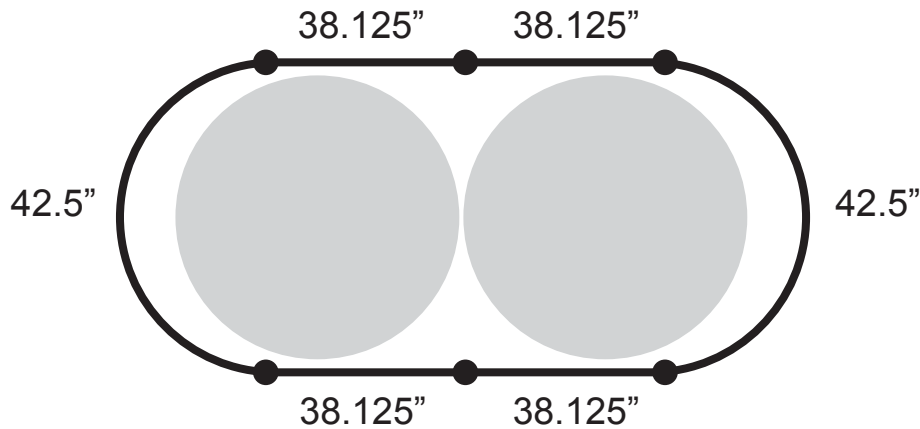



# Hanging Banner Hall I Lobby

Double Sided



**Sponsorship Location Fee**  
Coming Soon

**Printing & Installation Fee**  
Coming Soon

## Hanging Banner

120" x 96"



120"

96"



# Hanging Banner & Column Wrap Hall I Lobby

Double Sided

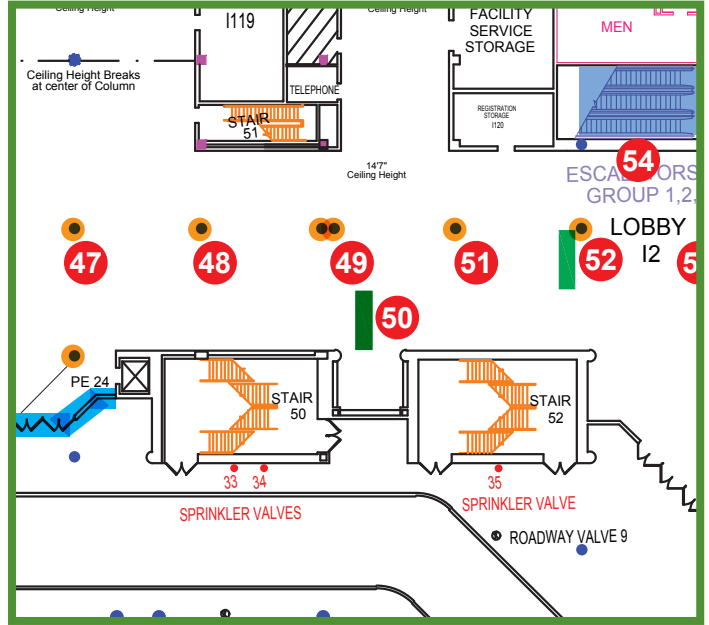

**Sponsorship Location Fee**  
Coming Soon

**Printing & Installation Fee**  
Coming Soon

## Hanging Banner

Coming Soon

## Column Wrap 16' tall

Wrap will be made with agam metal (see mockup at right)



120"

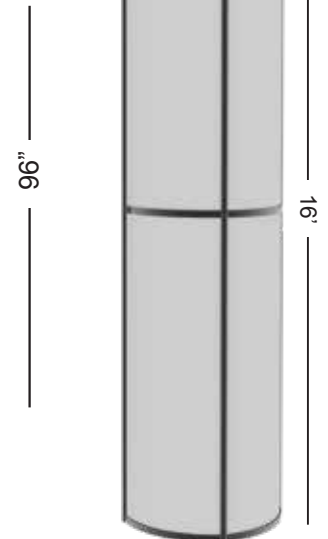

16'



# Hanging Banner & Column Wrap Hall I Lobby

OPPORTUNITY #52

Double Sided

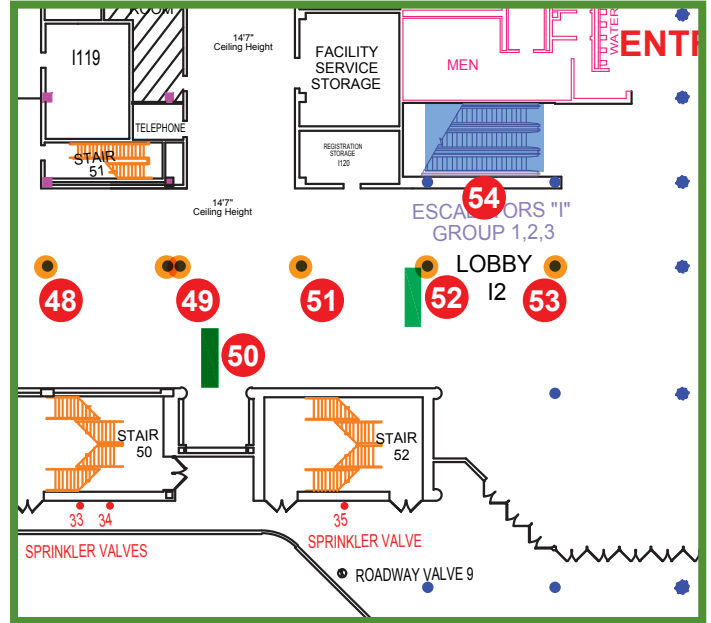

**Sponsorship Location Fee**  
Coming Soon

**Printing & Installation Fee**  
Coming Soon

## Hanging Banner

120" x 96"

## Column Wrap 16' tall

Wrap will be made with agam metal (see mockup at right)



120"

96"

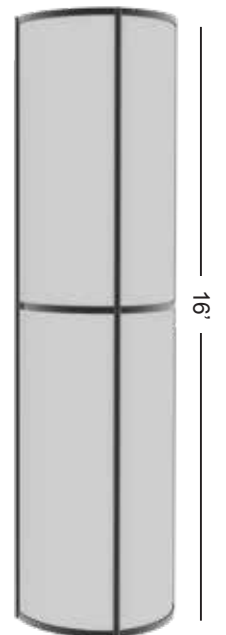

16'



# Column Wrap Hall I Lobby

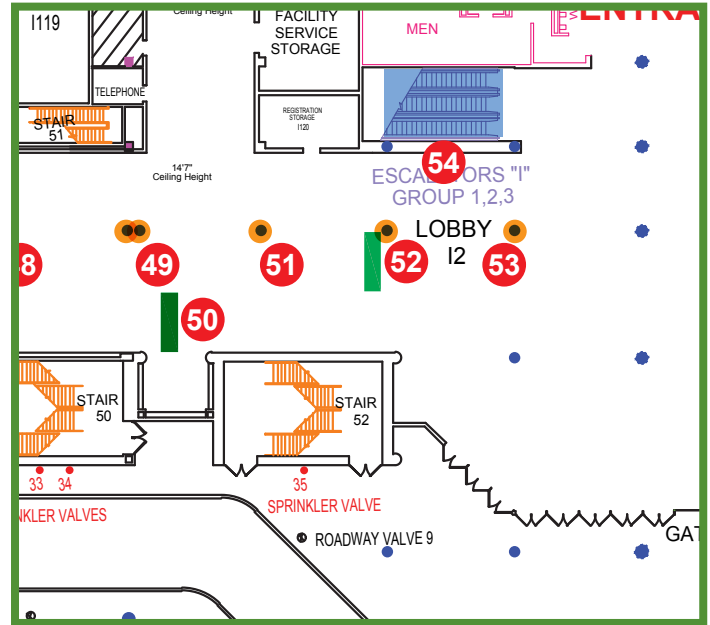

**Sponsorship Location Fee**  
Coming Soon

**Printing & Installation Fee**  
Coming Soon

## Column Wrap 16' tall

Wrap will be made with agam metal  
(see mockup at right)

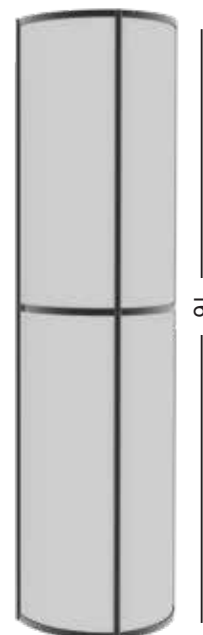



# Escalator Clings Hall I Lobby

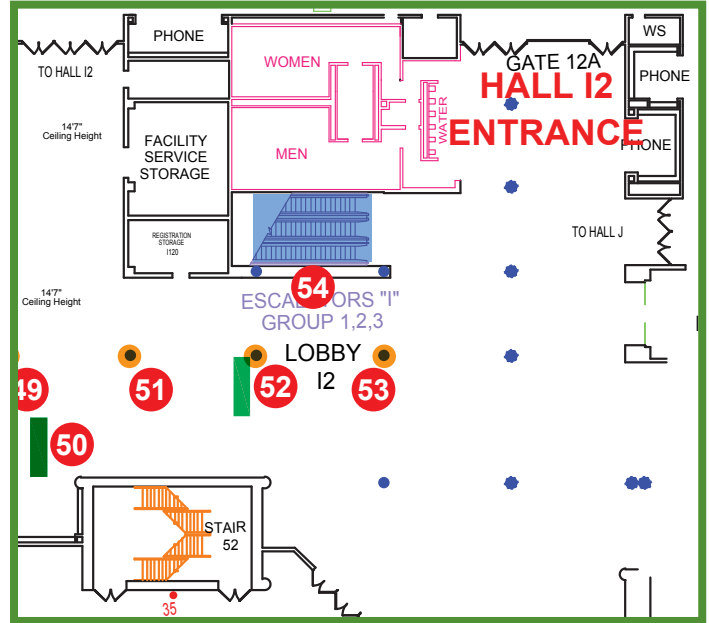

**Sponsorship Location Fee**  
Coming Soon

**Printing & Installation Fee**  
Coming Soon

## Escalator Clings

Metal Sides: 58' x 23.5" (x6)  
Flat Divider: 11.5" x 71' (x2)

## Additional Information

Escalator goes up to General Session, Education Sessions, Association Meetings.

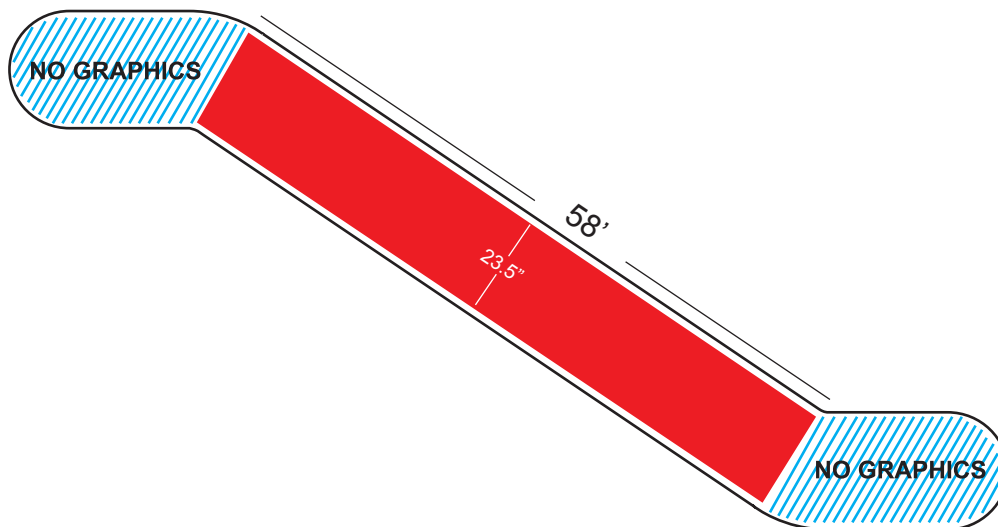



# Restroom Mirror Clings Near Room 260 (2nd Floor)

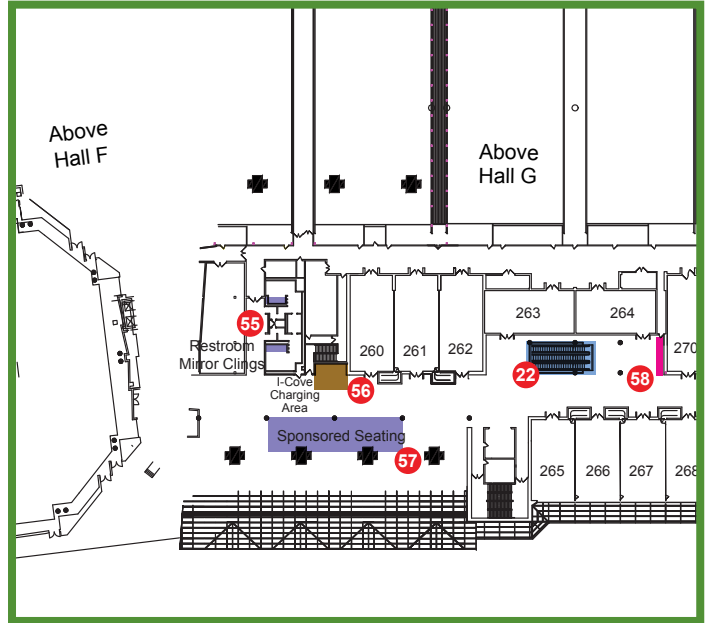

**Sponsorship Location Fee**  
Coming Soon

**Printing & Installation Fee**  
Coming Soon

**Mirror Clings** 16" x 16"

Clings placed on lower right corner of mirrors.  
(3-4 mirrors per restroom)

**Additional Information**

This opportunity includes the Men's and Women's restrooms in this location. Events in this area include Education and Association Meetings.



# I-Cove Charging Area, Wall Cling Near Room 260 (2nd Floor)

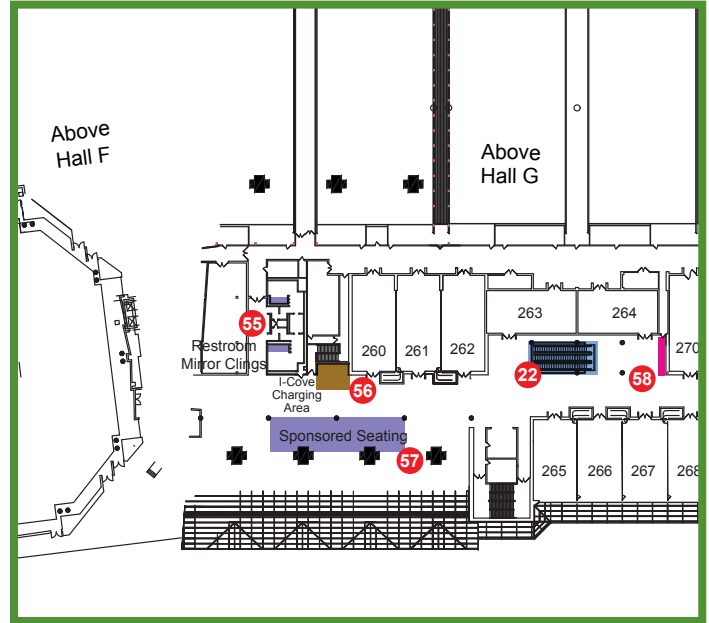

**Sponsorship Location Fee**  
Coming Soon

**Printing & Installation Fee**  
Coming Soon

## Wall Cling

Sponsor may cling white wall above coves.

## Location Information

I-Cove is a built-in charging station located in the Educational Sessions meeting room hallway.



### Lounge Seating Across From Room 260 (2nd Floor)

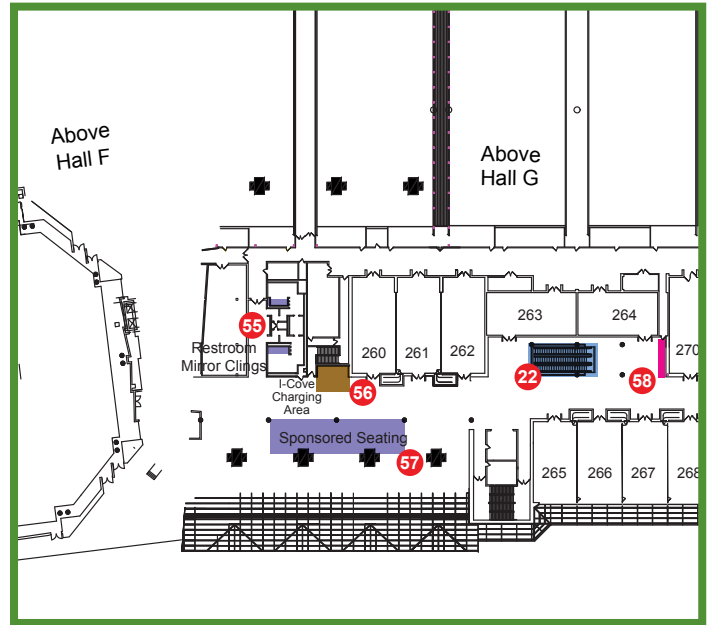

**Sponsorship Location Fee**  
Coming Soon

**Printing & Installation Fee**  
Coming Soon

### Sponsored Seating

Seating and coffee tables will be installed along the railing across from the I-Cove and Room 260 for Commodity Classic guests to continue their conversations between educational sessions. Opportunity includes two 4' x 4' lighted coffee table cubes with your company branding installed on the top surface and all four sides. Each cube will have outlets on the sides for your guests to use.

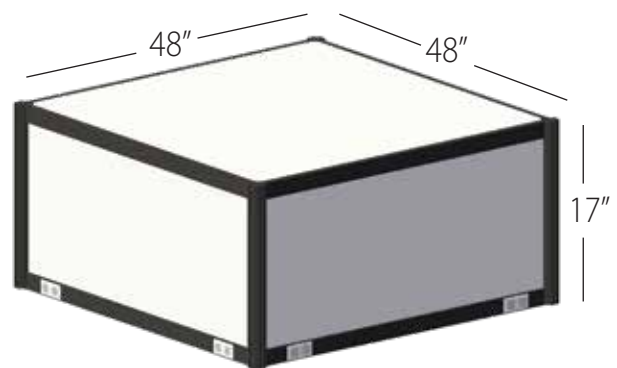



# Wall Cling Top of Escalator Across From Room 267 (2nd Floor)

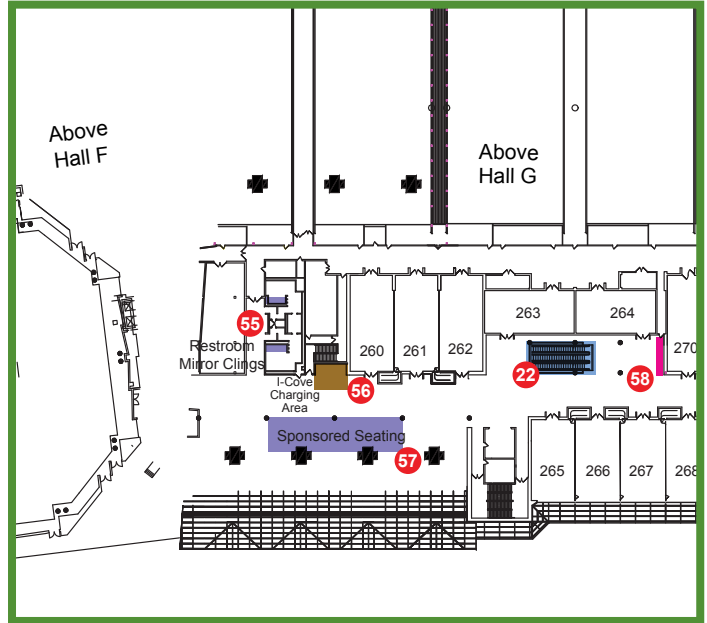

**Sponsorship Location Fee**  
Coming Soon

**Printing & Installation Fee**  
Coming Soon

## Wall Cling

Sponsor may place cling on soffit above brick wall.

## Location Information

Wall cling is visible when arriving to the 2nd floor via the Hall G Lobby escalators, and when walking through the lobby for the Education and General Session.



# Floor Cling Top of Escalator Across From Room 282 (2nd Floor)

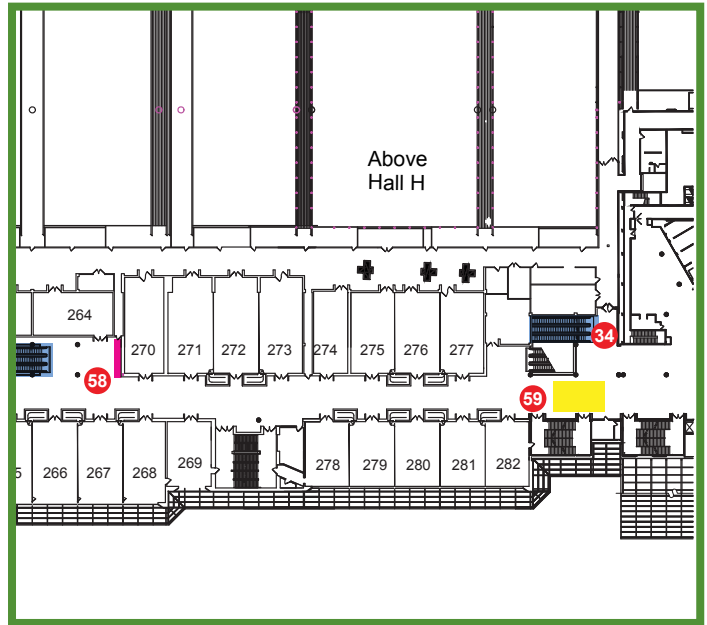
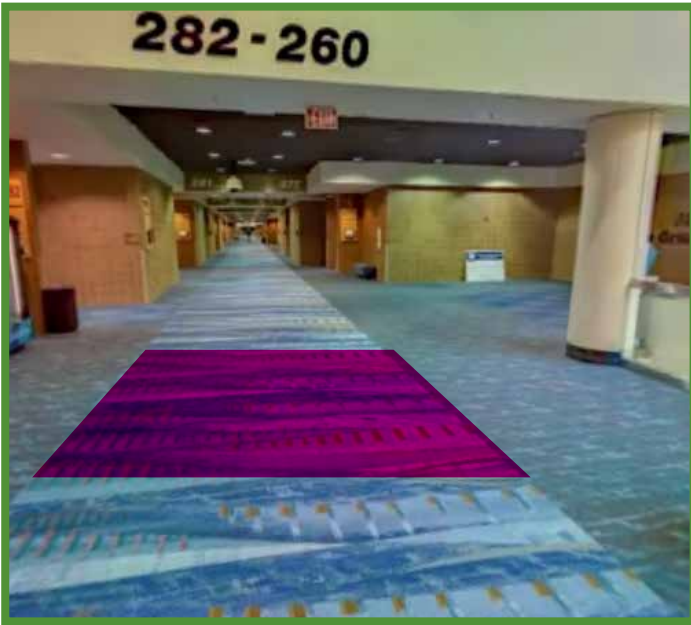

**Sponsorship Location Fee**  
Coming Soon

**Printing & Installation Fee**  
Coming Soon

### Floor Clings

Clings bigger than 50" x 50" will be tiled.

### Additional Information

Located between Room 282 and Escalator H.

Floor cling printing & installation pricing is dependent on quantity and size of clings within the given area.

